

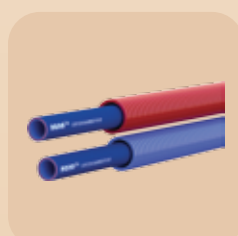

# KATALOG 2019

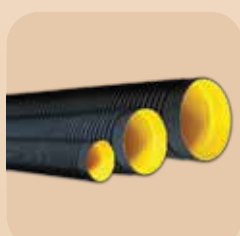

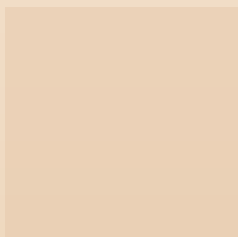
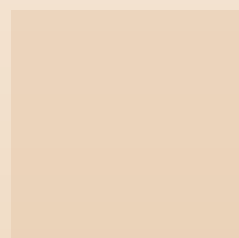
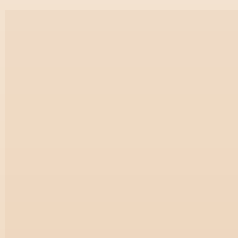
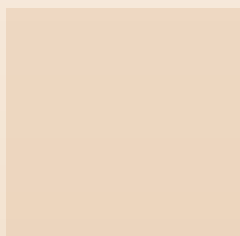
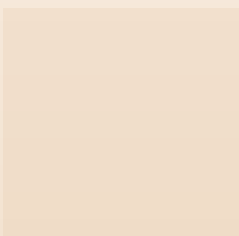
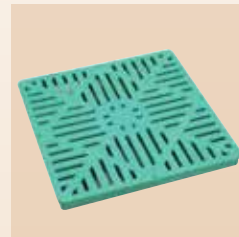
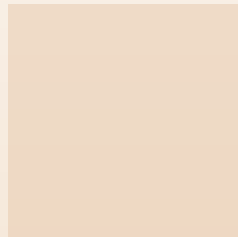
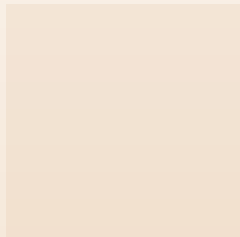
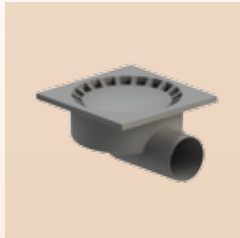
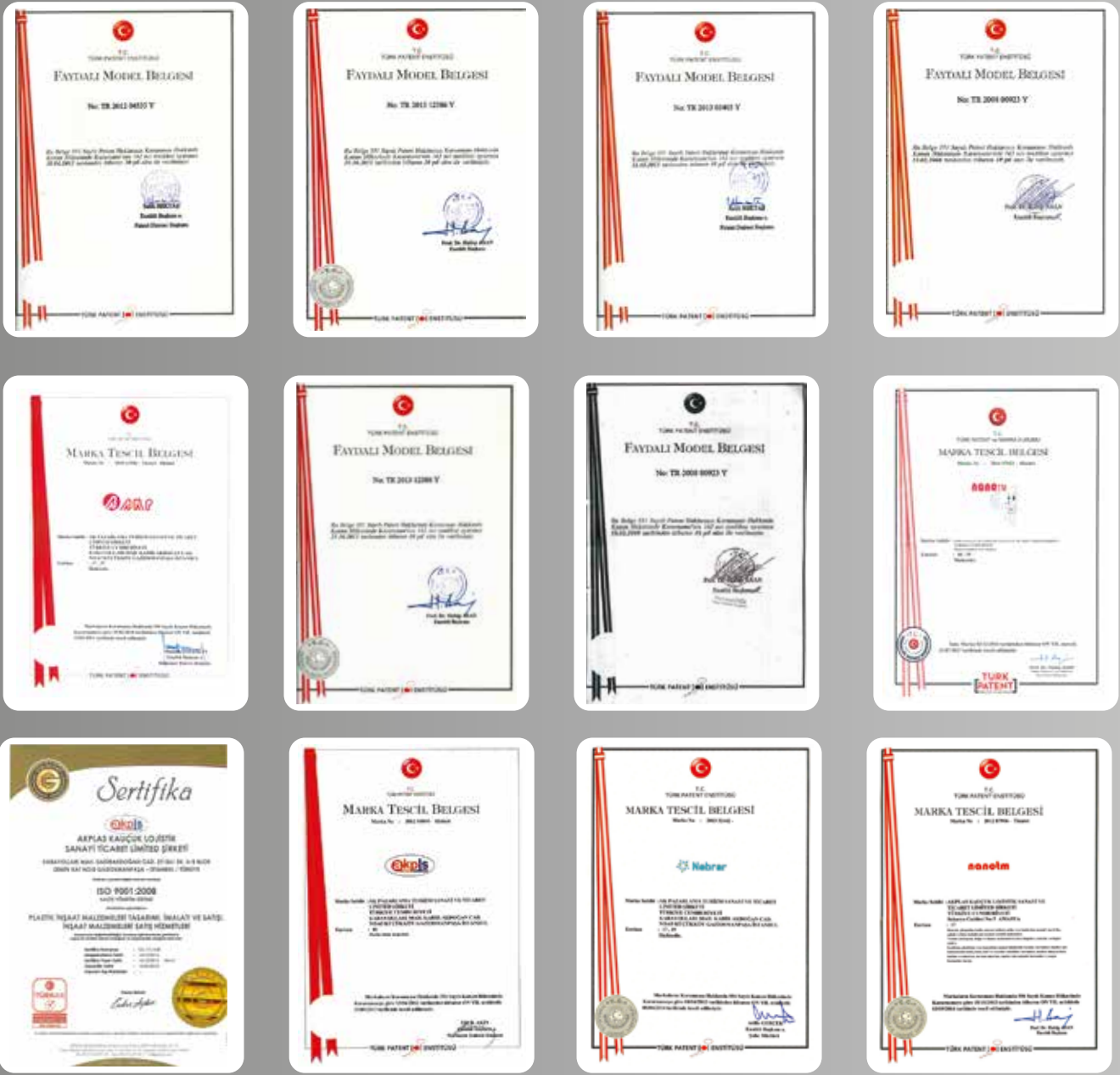

**1985** yılından beri inşaat ve altyapı sektöründeki tecrübelerimizi müşterilerimiz ile paylaşmaktayız. **Akplas Kauçuk Lojistik San. Tic. Ltd. Şti.** inşaat sektörü ile ilgili geliştirdiği patentli ürünlerin yanında boru ek parçaları, menhol, modüler su kanalları, süzgeç, duş kanalları, ısıtma-soğutma sistemlerinin üretimlerini ve satışlarını yapmaktadır. Amasya merkez olmak üzere, İstanbul bölgesine de hizmet veren firmamızın Kırklareli ve Irak-Erbil'de ürünlerimizin tedarik edilebileceği lojistik üsleri ve satış ofisleri bulunmaktadır. Türkiye'de 3000'i aşkın aktif müşterimize üretici firmamız olan **Akplas** olarak hizmet vermekteyiz. Avantajımız, sektörü iyi tanımamız ve sektörün ihtiyaçlarını iyi analiz etmemizdir. Sloganımız "Araştır, geliştir, üret, sat ve satış sonrası hizmet sağla" dır.

Müşterilerimizin isteklerine göre özel üremler de yapmaktayız. **Portföyümüzdeki ürün çeşitleri:** Bina içi tesisat PPRC borusu, PVC boru ve ek parçaları, PE-XB borular, oksijen bariyerli borular, ısıtma-soğutma sistemleri, siyah ve galvaniz doğalgaz boruları ve ek parçaları, yağmur olukları, bahçe ve sanayi hortumları, peyzaj sulama sistemleri, paslanmaz ızgaralı plastik duş kanalları, Modüler kanal sistemleri, havuz kenarı kanalları, izolasyonlu süzgeçleri, menhol, altyapı kanalizasyon boruları ve ek parçaları, HDPE kablo koruma boruları ve ek parçaları, drenaj boruları, polietilen borular...

**Kısaca hammaddesi plastik olan ve suya yön veren ürünler...**



Katalog 2019



## ÜST YAPI GRUBU

- Pis Su Boruları .....2
- Pis Su Bağlantı Elemanları ..... 3, 4, 5
- Çatı Olukları ve Bağlantı Elemanları .....6
- PP Boru-Ekipmanları, Trifonlu Kelepçeler .....7
- Su/Kalorifer Boruları ve Bağlantı Elemanları ..... 8, 9, 10, 11,12,13,14
- Doğalgaz Tesisatı Bağlantı Elemanları ve Montaj Setleri.....15,18
- Yerden Isıtma Borular ve Oksijen Bariyerli Borular .....16,17
- Kollektör Dolabı, İzolasyon Kılıf Boruları ..... 19
- Sıhhi Tesisat Döküm Ek Parçaları .....20, 21

## HORTUMLAR

- Emici / Verici Hortumlar, Klima, Jakuzi Hortumları .....22
- Su Hortumları, 3. Sınıf Polietilen, PE32 Yumuşak Polietilen.....23, 24, 25

## ZİRAİ SULAMA MALZEMELERİ

- Manşon, Dirsek, Adaptör, Redüksiyon .....26, 27
- Priz Kolye, Su Tutucu Bant, Çöp Konteyneri .....28
- Damlama Elemanları, Yağmurlama Başlıkları ve Roketler .....29
- Vana Kutuları, Damlama Borusu .....30

## SÜZGEÇLER ve DİĞERLERİ

- Modüler Kanal ve Izgaraları .....31, 32, 33
- Rögar Kapak ve Çerçevesi .....34
- Rögar Kutuları (25x25 - 35x35 Serisi) .....35
- Lineer Duş Kanal Serisi .....36, 37, 44
- Yükseklik Ayarlı Süzgeç ve Süzgeç Aksesuarlar ..... 38, 39, 40, 41, 42, 43
- Bahçe, Balkon, Dik İniş Süzgeçleri, Yaprak Tutucu .....45
- Paspayı ve Rogar Kutusu .....46, 47

## MUAYENE BACASI

- Muayene Bacaları ve Kapakları ..... 48, 49, 50, 51

## ALT YAPI GRUBU

- Drenaj Borusu, Manşon ve Şiltesi .....52
- Data Kablo Muhafaza Borusu ve Bağlantı Elemanları .....52
- PE100 Polietilen Borular .....53
- Korige Boru ve Bağlantı Elemanları .....54, 55
- PVC Temiz Su Boru ve Ek Parçaları .....56

**B - BD Tipi Pis Su Borusu TSE**
**1010**

Ürün Kod	Ölçü	Ambalaj	Fiyat
PSA11	50-150	150	3,40
PSA12	50-250	100	4,84
PSA13	50-500	20	8,04
PSA14	50-1000	10	13,67
PSA15	50-2000	10	22,15
PSA16	50-3000	10	32,99
PSA17	50-6000	10	65,72

**Tip 2 Pis Su Borusu**
**1012**

Ürün Kod	Ölçü	Ambalaj	Fiyat
PSB13	50-500	20	5,67
PSB14	50-1000	10	9,43
PSB15	50-2000	10	18,62
PSB16	50-3000	10	26,63
PSB17	50-6000	10	49,48

Ürün Kod	Ölçü	Ambalaj	Fiyat
PSA21	75-150	100	6,02
PSA22	75-250	60	8,54
PSA23	75-500	10	11,08
PSA24	75-1000	5	19,80
PSA25	75-2000	5	38,64
PSA26	75-3000	5	55,60
PSA27	75-6000	5	110,96

Ürün Kod	Ölçü	Ambalaj	Fiyat
PSB23	75-500	10	8,73
PSB24	75-1000	5	14,73
PSB25	75-2000	5	26,63
PSB26	75-3000	5	38,64
PSB27	75-6000	5	75,39

Ürün Kod	Ölçü	Ambalaj	Fiyat
PSA31	110-150	50	9,91
PSA32	110-250	30	12,97
PSA33	110-500	10	17,21
PSA34	110-1000	5	30,16
PSA35	110-2000	5	56,55
PSA36	110-3000	5	84,80
PSA37	110-6000	5	164,90

Ürün Kod	Ölçü	Ambalaj	Fiyat
PSB33	110-500	10	14,03
PSB34	110-1000	5	21,57
PSB35	110-2000	5	41,00
PSB36	110-3000	5	61,25
PSB37	110-6000	5	141,35

Ürün Kod	Ölçü	Ambalaj	Fiyat
PSA41	125-150	25	12,03
PSA42	125-250	20	16,73
PSA43	125-500	10	24,15
PSA44	125-1000	5	42,17
PSA45	125-2000	5	82,45
PSA46	125-3000	5	120,15
PSA47	125-6000	5	230,85

Ürün Kod	Ölçü	Ambalaj	Fiyat
PSB43	125-500	10	18,39
PSB44	125-1000	5	32,99
PSB45	125-2000	5	63,14
PSB46	125-3000	5	91,88
PSB47	125-6000	5	183,75

Ürün Kod	Ölçü	Ambalaj	Fiyat
PSA51	160-150	15	17,68
PSA52	160-250	10	24,51
PSA53	160-500	6	36,52
PSA54	160-1000	3	63,14
PSA55	160-2000	3	120,15
PSA56	160-3000	3	176,68
PSA57	160-6000	1	350,99

**B Tipi Pis Su Borusu TSE**
**1012**

Ürün Kod	Ölçü	Ambalaj	Fiyat
PSB53	160-500	6	30,63
PSB54	160-1000	3	56,55
PSB55	160-2000	3	106,00
PSB56	160-3000	3	155,48
PSB57	160-6000	1	301,52

Ürün Kod	Ölçü	Ambalaj	Fiyat
PSA61	200-150	1	29,45
PSA62	200-250	1	39,11
PSA63	200-500	2	65,97
PSA64	200-1000	1	101,30
PSA65	200-2000	1	193,17
PSA66	200-3000	1	287,39
PSA67	200-6000	1	560,63

Ürün Kod	Ölçü	Ambalaj	Fiyat
PSB63	200-500	1	50,65
PSB64	200-1000	1	89,52
PSB65	200-2000	1	171,97
PSB66	200-3000	1	235,57
PSB67	200-6000	1	452,28

Çap	Tip 1 Kalınlık mm	Tip 2 Kalınlık mm
50	3,00	1,80
75	3,00	1,80
110	3,20	2,20
125	3,20	2,50
160	4,00	3,20
200	4,90	3,90
250	6,20	4,90

250 ve 315 mm pis su borusu için fiyat isteyiniz.

**Açık Dirsek**
**1020**

Ürün Kod	Ölçü	Ambalaj	Fiyat
PAD02	50	200	2,37
PAD03	75	100	4,01
PAD04	110	40	8,30
PAD05	125	25	12,14
PAD06	160	15	25,21
PAD07	200	8	58,90
PAD12	50	200	1,89
PAD13	75	100	3,51
PAD14	110	35	6,86

**Kapalı Dirsek**
**1022**

Ürün Kod	Ölçü	Ambalaj	Fiyat
PKD02	50	200	2,84
PKD03	75	75	5,43
PKD04	110	30	10,37
PKD05	125	20	16,50
PKD06	160	16	33,46
PKD07	200	4	77,75
PKD12	50	200	2,11
PKD13	75	75	3,89
PKD14	100	30	7,89

**Tek Çatal**
**1030**

Ürün Kod	Ölçü	Ambalaj	Fiyat
PTC02	50 x 50	100	4,84
PTC03	75 x 50	50	7,40
PTC04	75 x 75	40	10,60
PTC05	110 x 50	30	11,55
PTC06	110 x 75	25	16,27
PTC07	110 x 110	15	19,80
PTC08	125 x 50 *	15	21,45
PTC09	125 x 75 *	15	24,27
PTC10	125 x 110	10	32,52
PTC11	125 x 125	10	38,64
PTC12	160 x 110	5	54,19
PTC13	160 x 125	5	67,50
PTC14	160 x 160	5	80,10
PTC15	200 x 110 *	4	149,11
PTC16	200 x 125 *	4	208,52
PTC17	200 x 160 *	3	202,79
PTC18	200 x 200 *	3	275,03
PTC32	50 x 50	100	3,86
PTC37	110 x 110	15	14,78

**TE Çatal**
**1032**

Ürün Kod	Ölçü	Ambalaj	Fiyat
PTE02	50 x 50	150	4,96
PTE03	75 x 50	50	7,67
PTE04	75 x 75	40	9,67
PTE05	110 x 50	35	11,32
PTE06	110 x 75	30	16,03
PTE07	110 x 110	20	17,44
PTE08	125 x 110 *	10	43,32
PTE09	125 x 125	10	35,72
PTE10	160 x 110	5	47,12
PTE11	160 x 125 *	6	89,77
PTE12	160 x 160	5	68,32
PTE13	200 x 110 *	4	166,21
PTE14	200 x 125 *	4	202,28
PTE15	200 x 160 *	3	217,51
PTE16	200 x 200 *	3	283,48

**Pis Su Redüksiyon**
**1040**

Ürün Kod	Ölçü	Ambalaj	Fiyat
PSR04	75-50	150	4,11
PSR05	110-50	75	6,49
PSR06	110-75	75	6,96
PSR07	125-75	50	12,72
PSR08	125-110	40	13,20
PSR09	160-110	10	21,92
PSR10	160-125	10	24,98
PSR11	200-110 *	1	106,79
PSR12	200-125 *	1	108,54
PSR13	200-160	1	54,14

**Pis Su Çift Çatal**
**1034**

Ürün Kod	Ölçü	Ambalaj	Fiyat
PCT01	50 x 50	75	8,73
PCT02	75 x 50	50	12,57
PCT03	75 x 75	10	19,80
PCT04	110 x 50	10	19,33
PCT05	110 x 75 *	10	59,63
PCT06	110 x 110	10	32,05
PCT07	125 x 110 *	10	86,86
PCT08	125 x 125 *	10	99,74

**Pis Su Havalık Bacası**
**1050**

Ürün Kod	Ölçü	Ambalaj	Fiyat
HVB01	75	50	13,00
HVB02	110	30	17,00

**Pis Su Muf Tapası**
**1052**

Ürün Kod	Ölçü	Ambalaj	Fiyat
PST02	40	900	0,66
PST03	50	750	0,78
PST04	75	250	1,40
PST05	110	125	1,93
PST06	125	100	3,53
PST07	160	50	5,52
PST08	200	30	8,89

**S Sifon**
**1046**

Ürün Kod	Ölçü	Ambalaj	Fiyat
PSE03	50/87	50	17,01
PSE04	75/45	40	25,69
PSE05	110/45	10	31,57
PSE14	75/87	40	25,69
PSE15	110/87	10	31,57
PSE45 *	110/45	10	20,76
PSE55 *	110/87	10	21,76

**Pis Su Temizleme**
**1044**

Ürün Kod	Ölçü	Ambalaj	Fiyat
PKT01	50 *	50	21,33
PKT02	75 *	50	26,42
PKT03	110	20	21,20
PKT04	125 *	10	69,80
PKT05	160 *	5	109,75
PKT06	200 *	4	247,74

**Pis Su Boru Contası**
**1080**

Ürün Kod	Ölçü	Ambalaj	Fiyat
CNT01	50	90	0,25
CNT02	75	60	0,37
CNT03	110	60	0,51
CNT04	125	50	1,69
CNT05	160	50	2,33
CNT06	200	50	3,21
CNT07	250	40	8,80
ESF11	Es Sifon	40	2,97

**Pis Su Kayar Manşon**
**1042**

Ürün Kod	Ölçü	Ambalaj	Fiyat
PSM01	50	250	3,43
PSM02	75	100	5,43
PSM03	110	40	9,43
PSM04	125 *	25	30,15
PSM05	160 *	10	52,81
PSM06	200 *	5	88,47

**PTK (Plastik Trifonlu Kelepçe)**
**1060**

Ürün Kod	Ölçü	Ambalaj	Fiyat
PTK01	50	120	3,62
PTK02	75	70	3,81
PTK03	110	40	4,66

**Pis Su Kelepçe**
**1062**

Ürün Kod	Ölçü	Ambalaj	Fiyat
PSK01	50	250	0,61
PSK02	75	200	0,97
PSK03	110	100	1,79
PSK04	125	80	3,58
PSK05	160	40	5,09

**Adaptör Conta**
**1072**

Ürün Kod	Ölçü	Ambalaj	Fiyat
ADC01	50 mm	400	1,27
ADC02	40 mm	1	4,86

**Seramik Taş Contası**
**1072**

Ürün Kod	Ölçü	Ambalaj	Fiyat
ADC03	Hela Taşı Contası	100	1,41
ADC04	Klozet Taşı Contası	100	1,55

## Pis Su Çelik Kapaklı Kilitli Çekvalf

1055



**Kilitli  
ve  
Paslanmaz  
Çelikten  
Kapak**

- Bakım ve montaj kolaylığı.
- Atık su geri tepmelerini önler.
- Fare ve haşere benzeri canlıların bina içine girişini engeller.

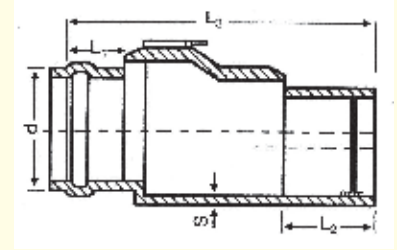

**DEKORATİF GÖRÜNÜM**

Ürün Kod	Ölçü	Ambalaj	Fiyat
PSC01	50	35	92,85
PSC02	75	40	104,86
PSC03	110	32	116,07
PSC04	125	32	163,29
PSC05	160	18	279,96
PSC06	200	12	466,67
PSC07	250	1	1.701,68
PSC08	315	1	2.382,53

Ø d	S mm	L1	L2	L3
110	3,5	65	64	318
125	4,1	75	71	318
160	4,1	70	70	350
200	4,1	110	89	450
250	6,2	144	104	566
315	7,7	183	144	728

EN 1455 ABS ve EN1401 PVC



## Pis Su Çift Çelik Kapaklı Kilitli Çekvalf

1055

## nanotm Pis Su Çelik Kapaklı Çekvalf

1055



Ürün Kod	Ölçü	Ambalaj	Fiyat
PSC13	110	32	162,49

Ürün Kod	Ölçü	Ambalaj	Fiyat
PSC23	110	8	72,79
PSC24	125	8	105,00
PSC25	160	8	126,98

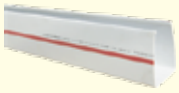
**150 mm Köşeli Çatı Oluk**
**1090**

Ürün Kod	Ölçü	Ambalaj	Fiyat
KDR01	Köşeli Oluk L=4 m.	4	93,05
KDE10	Köşeli Manşon	50	12,03
KDE11	Köşeli Dirsek	30	14,97
KDE12	Manşet 75	30	18,85
KDE13	Manşet 110 *	24	18,85
KDE14	Manşet Köşeli *	24	28,85
KDE15	Köşeli Kör Tapa	150	4,13

**Köşeli Profil İnş Boru**
**1096**

Ürün Kod	Ölçü	Ambalaj	Fiyat
PIB01	Profil İnş Borusu L=1 m *	4	32,65
PBE10	Profil Açık Dirsek *	50	10,91
PBE11	Profil Tek Çatal *	40	17,12
PBE12	Profil Çift Çatal *	40	28,58
PBE13	Profil Manşon *	100	15,65
PBE14	Profil Kelepçe *	200	1,67

**150 mm Köşeli Çatı Oluk Kelepçeleri**
**1091**

Ürün Kod	Ölçü	Ambalaj	Fiyat
KDK03	Plastik Askı	100	1,88

**150 mm Köşeli Çatı Oluk Kelepçeleri**
**1091**

Ürün Kod	Ölçü	Ambalaj	Fiyat
KDK02	Plastik Saç Saplı Askı	80	3,64
KDK01	Saç Oluk Askı Kalın Tıp	50	3,94

**Profil İnş Boru Özel Ek Parçaları**
**1097**

Ürün Kod	Ölçü	Ambalaj	Fiyat
POE01	Kapalı Yana Dirsek Konfeksiyon	1	32,26
POE02	Kapalı Öne Dirsek Konfeksiyon	1	32,26
POE03	75 mm Profile Geçiş Mufllu Adaptör	1	19,34
POE04	110 mm Profile Geçiş Mufllu Adaptör	1	21,38
POE05	Profilden 75 mm Geçiş Mufsuz Adaptör	1	19,34
POE06	Profilden 110 mm Geçiş Mufsuz Adaptör	1	21,38
POE07	75 mm Geçiş Adaptör Konfeksiyon	1	24,00
POE08	110mm Geçiş Adaptör Konfeksiyon	1	24,00



POE01



POE02



POE03



POE04



POE05



POE06

**100 mm Yuvarlak Çatı Oluk**
**1094**

Ürün Kod	Ölçü	Ambalaj	Fiyat
YDR01	Oluk *	5	63,44
YDE10	Manşon	30	10,56
YDE11	Dış Dirsek *	20	18,84
YDE12	İç Dirsek *	20	18,68
YDE13	Manşet 75 *	20	19,40
YDE14	Tapa *	200	5,12
YDE15	Askı	100	3,91

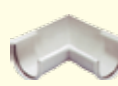
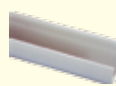



**40 PP Pis Su Boruları**
**1201**

Ürün Kod	Ölçü	Ambalaj	Fiyat
PSA10	40/150	70	4,04
PSA20	40/250	45	5,38
PSA30	40/500	25	5,98
PSA40	40/1000	25	10,90
PSA50	40/2000	25	20,94
PSA60	40/3000	25	31,05
PSA70	40/6000	25	63,96

**40 PP Açık Dirsek 45°**
**1220**

Ürün Kod	Ölçü	Ambalaj	Fiyat
PAD01	40	100	2,97

**40 PP Tek Çatal 45°**
**1230**

Ürün Kod	Ölçü	Ambalaj	Fiyat
PTC01	40/40	50	5,50

**40 PP Kapalı Dirsek 87,5°**
**1222**

Ürün Kod	Ölçü	Ambalaj	Fiyat
PKD01	40	100	3,15

**40 PP Te Çatal 87,5°**
**1232**

Ürün Kod	Ölçü	Ambalaj	Fiyat
PTE01	40/40	50	5,28

**40 PP Redüksiyon**
**1240**

Ürün Kod	Ölçü	Ambalaj	Fiyat
PSR03	50/40	100	3,13

**40 PP Kayar Manşon**
**1242**

Ürün Kod	Ölçü	Ambalaj	Fiyat
PSM00	40	100	3,52

**Standart Trifonlu Kelepçe**
**1511**

Ürün Kod	Ölçü	Ambalaj	Fiyat
STK01	1/2"	400	1,53
STK02	3/4"	300	1,70
STK03	1"	250	1,83
STK04	1 1/4"	175	2,19
STK05	1 1/2"	150	2,39
STK06	2"	125	2,68
STK07	2 1/2"	60	4,61
STK08	3"	50	5,20
STK09	4"	45	6,57
STK10	4 1/2"	40	9,51

**Somunlu Trifonlu Kelepçe**
**1531**

Ürün Kod	Ölçü	Ambalaj	Fiyat
SMK01	1/2"	500	1,53
SMK02	3/4"	400	1,70
SMK03	1"	300	1,83
SMK04	1 1/4"	250	2,19
SMK05	1 1/2"	200	2,39
SMK06	2"	150	2,68
SMK07	2 1/2"	75	4,61
SMK08	3"	50	5,65
SMK09	4"	50	6,57
SMK10	4 1/2"	45	9,51
SMK11	5"	25	9,81
SMK12	6"	20	11,14
SMK13	8"	10	13,91

**Uzun Trifonlu Kelepçe**
**1521**

Ürün Kod	Ölçü	Ambalaj	Fiyat
UTK01	1/2"	300	1,77
UTK02	3/4"	250	1,92
UTK03	1"	225	2,01
UTK04	1 1/4"	150	2,35
UTK05	1 1/2"	125	2,60
UTK06	2"	100	2,87
UTK07	2 1/2"	50	4,79
UTK08	3"	50	7,37
UTK09	4"	40	7,39

**PPRC Boru PN 20 (20 ATÜ)**
**2003**

Ürün Kod	Ölçü	Ambalaj	Fiyat
PPB21	20 x 3,4 mm	100	5,37
PPB22	25 x 4,2 mm	100	8,28
PPB23	32 x 5,4 mm	60	15,65
PPB24	40 x 6,7 mm	40	24,51
PPB25	50 x 8,4 mm	20	38,16
PPB26	63 x 10,5 mm	16	59,61
PPB27	75 x 12,5 mm	12	92,82
PPB28	90 x 15,0 mm	8	155,48
PPB29	110 x 18,4 mm	4	233,20
PPB30	125 x 20,9 mm	4	294,45

**Kompozit Boru PN 25 (25 ATÜ)**
**2012**

Ürün Kod	Ölçü	Ambalaj	Fiyat
PPK11	20 x 3.4 mm	100	6,46
PPK12	25 x 4.2 mm	100	9,79
PPK13	32 x 5.4 mm	60	17,09
PPK14	40 x 6.7 mm	40	26,39
PPK15	50 x 8.4 mm	20	41,23
PPK16	63 x 10.5 mm	16	63,60
PPK17	75 x 12.5 mm	12	101,30
PPK18	90 x 15.0 mm	8	155,51
PPK19	110 x 18.4 mm	4	233,31
PPK20	125 x 20,9 mm	4	294,47

**PPRC Boru PN 16 (16 ATÜ)**
**2002**

Ürün Kod	Ölçü	Ambalaj	Fiyat
PPB11	20 x 2,8 mm	100	4,96
PPB12	25 x 3,5 mm	100	7,61
PPB13	32 x 4,4 mm	60	13,67
PPB14	40 x 5,5 mm	40	21,92
PPB15	50 x 6,9 mm	20	32,28
PPB16	63 x 8,6 mm	16	47,59
PPB17	75 x 10,3 mm	12	76,57

**Kompozit Boru PN 20 (20 ATÜ)**
**2011**

Ürün Kod	Ölçü	Ambalaj	Fiyat
PPK01	20 x 2.8 mm	100	5,55
PPK02	25 x 3.5 mm	100	8,25
PPK03	32 x 4.4 mm	60	14,15
PPK04	40 x 5.5 mm	40	22,39
PPK05	50 x 6.9 mm	20	32,86
PPK06	63 x 8.6 mm	16	49,48
PPK07	75 x 10.3 mm	12	80,10
PPK08	90 x 12.3 mm	8	127,20
PPK09	110 x 15.1 mm	4	181,39
PPK10	125 x 20,9 mm	4	254,40

**PPRC Ortadan Folyolu Kombi Borusu (25 ATÜ)**
**2021**

Ürün Kod	Ölçü	Ambalaj	Fiyat
POF01	20 x 3,4 mm	100	8,96
POF02	25 x 4,2 mm	80	12,26
POF03	32 x 5,4 mm	60	20,74
POF04	40 x 6,7 mm	40	32,52
POF05	50 x 8,4 mm	20	51,83
POF06	63 x 10,5 mm	16	80,10
POF07	75 x 12,5 mm	12	127,20

**PPRC Stabil Boru (Alüminyum Folyolu)**
**2022**

Ürün Kod	Ölçü	Ambalaj	Fiyat
PPF01	20 x 3,4 mm	100	8,96
PPF02	25 x 4,2 mm	100	12,26
PPF03	32 x 5,4 mm	60	20,74
PPF04	40 x 6,7 mm	40	32,52



**PPRC 90° Dirsek**
**2111**

Ürün Kod	Ölçü	Ambalaj	Fiyat
PPD01	20 mm	400	0,64
PPD02	25 mm	200	1,02
PPD03	32 mm	100	1,89
PPD04	40 mm	75	3,43
PPD05	50 mm	40	6,61
PPD06	63 mm	20	13,20
PPD07	75 mm	12	21,20
PPD08	90 mm	8	39,82
PPD09	110 mm	3	61,25
PPD10	125 mm	1	129,57

**PPRC 45° Dirsek**
**2112**

Ürün Kod	Ölçü	Ambalaj	Fiyat
PPD11	20 mm	400	0,87
PPD12	25 mm	250	1,26
PPD13	32 mm	150	1,99
PPD14	40 mm	80	3,76
PPD15	50 mm	40	6,84
PPD16	63 mm	20	12,26
PPD17	75 mm	12	21,68
PPD18	90 mm	5	41,00
PPD19	110 mm	3	67,84

**PPRC Manşon**
**2101**

Ürün Kod	Ölçü	Ambalaj	Fiyat
PPM01	20 mm	500	0,48
PPM02	25 mm	320	0,77
PPM03	32 mm	200	1,43
PPM04	40 mm	100	2,37
PPM05	50 mm	60	4,24
PPM06	63 mm	32	7,55
PPM07	75 mm	24	12,26
PPM08	90 mm	16	22,15
PPM09	110 mm	10	33,92
PPM10	125 mm	6	65,97

**PPRC Kapama Başlığı**
**2151**

Ürün Kod	Ölçü	Ambalaj	Fiyat
PKB01	20 mm	500	0,56
PKB02	25 mm	500	0,79
PKB03	32 mm	300	1,35
PKB04	40 mm	160	1,75
PKB05	50 mm	100	3,16
PKB06	63 mm	50	7,08
PKB07	75 mm	32	12,72
PKB08	90 mm	24	20,36
PKB09	110 mm	10	32,52

**PPRC TE Parçası**
**2121**

Ürün Kod	Ölçü	Ambalaj	Fiyat
PPT01	20 mm	250	0,95
PPT02	25 mm	150	1,43
PPT03	32 mm	60	2,84
PPT04	40 mm	50	4,39
PPT05	50 mm	30	8,73
PPT06	63 mm	20	19,33
PPT07	75 mm	10	28,75
PPT08	90 mm	5	51,83
PPT09	110 mm	2	73,03
PPT10	125 mm	1	153,12

**PPRC Kavis**
**2181**

Ürün Kod	Ölçü	Ambalaj	Fiyat
KVS01	20 mm	100	2,46
KVS02	25 mm	60	3,92
KVS03	32 mm	40	7,31

**PPRC Kısa Manşonlu Kavis**
**2182**

Ürün Kod	Ölçü	Ambalaj	Fiyat
KMK01	20 mm	200	1,66
KMK02	25 mm	100	2,38

**PPRC Uzun Manşonlu Kavis**
**2183**

Ürün Kod	Ölçü	Ambalaj	Fiyat
UMK01	20 mm	120	1,86
UMK02	25 mm	90	3,08
UMK03	32 mm	50	8,96

## PPRC İnegal Te

2124



Ürün Kod	Ölçü	Ambalaj	Fiyat
PIN01	25 x 20 x 20 mm	160	1,66
PIN02	25 x 20 x 25 mm	160	1,66
PIN03	25 x 25 x 20 mm	160	1,66
PIN04	25 x 32 x 25 mm	100	2,95
PIN05	32 x 20 x 20 mm	100	2,95
PIN06	32 x 20 x 25 mm	100	2,95
PIN07	32 x 20 x 32 mm	100	2,95
PIN08	32 x 25 x 20 mm	100	2,95
PIN09	32 x 25 x 25 mm	100	2,95
PIN10	32 x 25 x 32 mm	100	2,95
PIN11	32 x 32 x 20 mm	100	2,95
PIN12	32 x 32 x 25 mm	100	2,95
PIN13	32 x 40 x 32 mm	50	4,58
PIN14	32 x 50 x 32 mm	50	11,79
PIN15	40 x 20 x 40 mm	50	4,58
PIN16	40 x 25 x 32 mm	50	4,58
PIN17	40 x 25 x 40 mm	50	4,58
PIN18	40 x 32 x 40 mm	50	4,58
PIN19	40 x 50 x 40 mm	40	10,94
PIN20	50 x 20 x 50 mm	30	8,25
PIN21	50 x 25 x 50 mm	30	8,48
PIN22	50 x 32 x 32 mm	30	10,94
PIN23	50 x 32 x 40 mm	30	10,94
PIN24	50 x 32 x 50 mm	30	9,20
PIN25	50 x 40 x 32 mm	30	10,94
PIN26	50 x 40 x 40 mm	30	10,94
PIN27	50 x 40 x 50 mm	30	9,67
PIN28	50 x 50 x 32 mm	30	10,94
PIN29	50 x 50 x 40 mm	30	10,94
PIN30	63 x 20 x 63 mm	20	16,21
PIN31	63 x 25 x 63 mm	20	16,21
PIN32	63 x 32 x 63 mm	20	16,21
PIN33	63 x 40 x 63 mm	20	18,39
PIN34	63 x 50 x 63 mm	20	18,39
PIN35	75 x 20 x 75 mm	10	41,00
PIN36	75 x 25 x 75 mm	10	41,00
PIN37	75 x 32 x 75 mm	10	41,00
PIN38	75 x 40 x 75 mm	10	41,00
PIN39	75 x 50 x 75 mm	10	41,00
PIN40	75 x 63 x 75 mm	10	41,00
PIN41	90 x 40 x 90 mm	5	70,68
PIN42	90 x 50 x 90 mm	5	70,68
PIN43	90 x 63 x 90 mm	5	70,68
PIN44	90 x 75 x 90 mm	5	70,68
PIN45	110 x 50 x 110 mm	3	106,00
PIN46	110 x 63 x 110 mm	3	106,00
PIN47	110 x 75 x 110 mm	2	106,00
PIN48	110 x 90 x 110 mm	2	106,00

## PPRC Redüksiyon

2128



Ürün Kod	Ölçü	Ambalaj	Fiyat
PPR01	25 x 20 mm	500	0,56
PPR02	32 x 20 mm	300	0,77
PPR03	32 x 25 mm	300	0,83
PPR04	40 x 20 mm	200	1,47
PPR05	40 x 25 mm	200	1,56
PPR06	40 x 32 mm	160	1,80
PPR07	50 x 20 mm	100	2,32
PPR08	50 x 25 mm	100	2,37
PPR09	50 x 32 mm	100	2,70
PPR10	50 x 40 mm	100	3,12
PPR11	63 x 20 mm	60	4,49
PPR12	63 x 25 mm	60	4,63
PPR13	63 x 32 mm	60	5,43
PPR14	63 x 40 mm	60	5,67
PPR15	63 x 50 mm	40	6,13
PPR16	75 x 20 mm	50	8,96
PPR17	75 x 25 mm	50	9,20
PPR20	75 x 50 mm	40	8,48
PPR21	75 x 63 mm	32	10,60
PPR24	90 x 32 mm	50	14,15
PPR25	90 x 40 mm	40	18,39
PPR26	90 x 50 mm	10	19,33
PPR27	90 x 63 mm	10	23,57
PPR28	90 x 75 mm	10	28,28
PPR32	110 x 40 mm	20	23,58
PPR33	110 x 50 mm	20	28,29
PPR34	110 x 63 mm	16	32,99
PPR35	110 x 75 mm	15	42,40
PPR36	110 x 90 mm	12	51,83

## PPRC İstavroz Te

2125



Ürün Kod	Ölçü	Ambalaj	Fiyat
IST01	20 mm	150	1,99
IST02	25 mm	100	2,84
IST03	32 mm	60	4,82
IST04	40 mm	40	8,25

## PPRC Dişli Kör Tapa

2161



Ürün Kod	Ölçü	Ambalaj	Fiyat
DKT01	20 x 1/2"	250	0,37
DKT02	25 x 3/4"	200	0,48
DKT03	32 x 1"	100	0,49

## PPRC Uzun Dişli Kör Tapa

2161



Ürün Kod	Ölçü	Ambalaj	Fiyat
DKT31	20 x 1/2"	100	0,52

**PPRC Geçme Dirsek (İç Dişli)**
**2113**

Ürün Kod	Ölçü	Ambalaj	Fiyat
PID01	20 x 1/2"	200	5,17
PID02	20 x 3/4"	150	7,34
PID03	25 x 1/2"	150	5,47
PID04	25 x 3/4"	150	7,29
PID05	32 x 1/2"	50	9,43
PID06	32 x 3/4"	50	10,37
PID07	32 x 1"	50	13,91

**PPRC Geçme Dirsek (Dış Dişli)**
**2114**

Ürün Kod	Ölçü	Ambalaj	Fiyat
PDD01	20 x 1/2"	160	6,61
PDD02	20 x 3/4"	100	10,04
PDD03	25 x 1/2"	100	7,55
PDD04	25 x 3/4"	100	9,67
PDD05	32 x 3/4"	50	12,26
PDD06	32 x 1"	50	18,62

**PPRC Rakor Yuvarlak (İç Dişli)**
**2131**

Ürün Kod	Ölçü	Ambalaj	Fiyat
PIA01	20 x 1/2"	200	4,98
PIA02	20 x 3/4"	150	6,96
PIA03	25 x 1/2"	150	5,34
PIA04	25 x 3/4"	150	6,84
PIA05	32 x 1/2"	100	12,26
PIA06	32 x 3/4"	100	8,42
PIA07	32 x 1"	80	16,27

**PPRC Rakor Yuvarlak (Dış Dişli)**
**2133**

Ürün Kod	Ölçü	Ambalaj	Fiyat
PDA01	20 x 1/2"	180	5,99
PDA02	20 x 3/4"	100	9,91
PDA03	25 x 1/2"	100	7,08
PDA04	25 x 3/4"	100	9,20
PDA06	32 x 3/4"	100	12,03
PDA07	32 x 1"	80	18,24

**PPRC Rakor Altı Köşe (İç Dişli)**
**2132**

Ürün Kod	Ölçü	Ambalaj	Fiyat
PIA08	32 x 1"	80	18,15
PIA09	40 x 1 1/4"	50	28,28
PIA10	50 x 1 1/2"	40	37,70
PIA11	63 x 2"	20	63,60
PIA12	75 x 2 1/2"	15	113,08
PIA13	90 x 3"	8	190,80
PIA14	110 x 4"	5	226,15

**PPRC Rakor Altı Köşe (Dış Dişli)**
**2134**

Ürün Kod	Ölçü	Ambalaj	Fiyat
PDA08	32 x 1"	80	20,62
PDA09	40 x 1 1/4"	40	36,04
PDA10	50 x 1 1/2"	32	44,77
PDA11	63 x 2"	16	69,50
PDA12	75 x 2 1/2"	12	131,92
PDA13	90 x 3"	8	195,52
PDA14	110 x 4"	5	339,20

**PPRC Sıva Altı Batarya Bağlantısı (İç Dişli)**
**2191**

Ürün Kod	Ölçü	Ambalaj	Fiyat
SBB01	20 x 1/2"	160	5,60
SBB02	25 x 1/2"	160	6,61
SBB03	25 x 3/4"	100	8,25

**PPRC Sıva Altı Batarya Bağlantısı (Dış Dişli)**
**2191**

Ürün Kod	Ölçü	Ambalaj	Fiyat
SBB21	20 x 1/2"	100	7,55
SBB22	25 x 1/2"	100	8,48
SBB23	25 x 3/4"	100	9,91

**PPRC Geçme Batarya (İç Dişli)**
**2191**

Ürün Kod	Ölçü	Ambalaj	Fiyat
GEB31	20 x 1/2"	24	6,84
GEB32	25 x 1/2"	24	7,08

**PPRC Geçme Batarya (Dış Dişli)**
**2191**

Ürün Kod	Ölçü	Ambalaj	Fiyat
GEB41	20 x 1/2"	24	8,48
GEB42	25 x 1/2"	24	9,20

**PPRC Geçme Te Parçası (İç Dişli)**
**2122**

Ürün Kod	Ölçü	Ambalaj	Fiyat
PIT01	20 x 1/2" x 20	160	5,24
PIT02	20 x 3/4" x 20	160	7,55
PIT03	25 x 1/2" x 25	100	6,36
PIT04	25 x 3/4" x 25	100	7,56
PIT05	32 x 1/2" x 32	50	9,43
PIT06	32 x 3/4" x 32	50	11,79
PIT07	32 x 1" x 32	50	14,38

**PPRC Geçme Te Parçası (Dış Dişli)**
**2123**

Ürün Kod	Ölçü	Ambalaj	Fiyat
PDT01	20 x 1/2" x 20	150	7,15
PDT02	20 x 3/4" x 20	100	10,04
PDT03	25 x 1/2" x 25	100	8,02
PDT04	25 x 3/4" x 25	100	10,26
PDT05	32 x 3/4" x 32	50	15,56
PDT06	32 x 1" x 32	50	17,68

**PPRC Sabit Batarya Bağlantısı**
**2193**

Ürün Kod	Ölçü	Ambalaj	Fiyat
CBB01	20 x 1/2"	60	12,04
CBB02	25 x 1/2"	60	12,44

**PPRC Taharet Batarya Bağlantısı**
**2194**

Ürün Kod	Ölçü	Ambalaj	Fiyat
TBB01	20 x 1/2"	50	11,83

**PPRC Sabit Batarya Bağlantısı Dış Dişli (Çiftli)**
**2192**

Ürün Kod	Ölçü	Ambalaj	Fiyat
DDB11	20 x 1/2"	40	16,96
DDB12	25 x 1/2"	40	16,50

**PPRC Ayarlı Batarya Bağlantısı (Çiftli)**
**2192**

Ürün Kod	Ölçü	Ambalaj	Fiyat
ABB01	20 x 1/2"	50	17,68
ABB02	25 x 1/2"	50	16,96

**PPRC Oynar Başlıklı Rakor (İç Dişli)**
**2135**

Ürün Kod	Ölçü	Ambalaj	Fiyat
IOB01	20 x 1/2"	200	10,17
IOB02	25 x 3/4"	100	14,71
IOB03	32 x 1"	60	16,32
IOB04	40 x 1 1/4"	50	37,44
IOB05	50 x 1 1/2"	40	67,56
IOB06	63 x 2"	8	112,13
IOB07	75 x 2 1/2"	15	212,00

**PPRC Oynar Başlıklı Rakor (Dış Dişli)**
**2136**

Ürün Kod	Ölçü	Ambalaj	Fiyat
DOB01	20 x 1/2"	200	10,96
DOB02	25 x 3/4"	100	16,04
DOB03	32 x 1"	100	18,72
DOB04	40 x 1 1/4"	50	42,79
DOB05	50 x 1 1/2"	32	73,31
DOB06	63 x 2"	16	117,88
DOB07	75 x 2 1/2"	12	256,77
DOB12	25 x 1"	120	20,47

**PPRC Filtre Erkek**
**2147**

Ürün Kod	Ölçü	Ambalaj	Fiyat
PFL01	20	100	12,09
PFL02	25	70	15,48
PFL03	32	50	29,45

**PPRC Filtre Dişi**
**2147**

Ürün Kod	Ölçü	Ambalaj	Fiyat
PFL11	20	20	12,42
PFL12	25	25	15,91
PFL13	32	32	22,97

**PPRC Hareketli Nipel**
**2148**

Ürün Kod	Ölçü	Ambalaj	Fiyat
PHN21	20 x 1/2"	250	10,14
PHN22	25 x 3/4"	150	12,11

**PPRC Hareketli Dirsek**
**2148**

Ürün Kod	Ölçü	Ambalaj	Fiyat
PHD01	20 x 1/2"	200	10,14
PHD02	25 x 3/4"	150	12,41

**PPRC Hareketli TE**
**2126**

Ürün Kod	Ölçü	Ambalaj	Fiyat
PHT01	20 x 1/2"	150	19,39
PHT02	20 x 3/4"	150	22,63
PHT03	25 x 3/4"	100	23,09
PHT04	25 x 1"	100	29,45
PHT05	32 x 1"	100	40,05
PHT06	32 x 1 1/4"	80	44,77



**PPRC Kelebek Başlı Vana (Stop Vana)**
**2141**

Ürün Kod	Ölçü	Ambalaj	Fiyat
PSV01	20 mm	80	19,63
PSV02	25 mm	56	22,44
PSV03	32 mm	50	43,47
PSV04	40 mm	30	51,83

**PPRC Eko Küresel Vana**
**2142**

Ürün Kod	Ölçü	Ambalaj	Fiyat
PKV11	20 mm	100	8,29
PKV12	25 mm	40	10,96
PKV13	32 mm	25	16,04
PKV14	40 mm	48	41,69
PKV15	50 mm	28	48,88

**PPRC Kollu Mini Küresel Vana**
**2142**

Ürün Kod	Ölçü	Ambalaj	Fiyat
PKV31	20 mm		8,99
PKV32	25 mm		11,50
PKV33	32 mm		16,22

**PPRC Dış Dışlı Küresel Vana**
**2142**

Ürün Kod	Ölçü	Ambalaj	Fiyat
PKV51	20 mm		26,09
PKV52	25 mm		33,91
PKV53	32 mm		44,23

**PPRC Çift Yönlü Küresel Vana**
**2142**

Ürün Kod	Ölçü	Ambalaj	Fiyat
PKV71	20 mm		53,07
PKV72	25 mm		73,72
PKV73	32 mm		98,79
PKV74	40 mm		147,44
PKV75	50 mm		250,64

**PPRC Sıva Altı Kromlu Vana**
**2143**

Ürün Kod	Ölçü	Ambalaj	Fiyat
PLK01	20 mm	40	59,42
PLK02	25 mm	40	63,25
PLK03	32 mm	40	74,75

**PPRC Termokulp Vana**
**2144**

Ürün Kod	Ölçü	Ambalaj	Fiyat
PTV01	25	200	39,07
PTV02	32	100	41,29

**PPRC Küresel Vana**
**2142**

Ürün Kod	Ölçü	Ambalaj	Fiyat
PKV01	20 mm	100	10,57
PKV02	25 mm	40	14,18
PKV03	32 mm	25	20,06
PKV04	40 mm	48	60,38
PKV05	50 mm	28	69,00
PKV06	63 mm	15	107,81
PKV07	75 mm	12	123,63

**PPRC Mini Küresel Vana**
**2142**

Ürün Kod	Ölçü	Ambalaj	Fiyat
PKV21	20 mm	150	8,99
PKV22	25 mm	100	11,50
PKV23	32 mm	100	16,67

**PPRC İç Dışlı Küresel Vana**
**2142**

Ürün Kod	Ölçü	Ambalaj	Fiyat
PKV41	20 mm		24,32
PKV42	25 mm		30,96
PKV43	32 mm		38,33

**PPRC Tek Yönlü Küresel Vana**
**2142**

Ürün Kod	Ölçü	Ambalaj	Fiyat
PKV61	20 mm		38,33
PKV62	25 mm		42,76
PKV63	32 mm		70,77
PKV64	40 mm		117,94
PKV65	50 mm		199,04

**PPRC Kollektor Vanası**
**2145**

Ürün Kod	Ölçü	Ambalaj	Fiyat
KPV01	25 x 1"	20	58,97
KPV02	32 x 1"	20	62,04

**PPRC Su Sayacı ve Kalorimetre Vanası**
**2146**

Ürün Kod	Ölçü	Ambalaj	Fiyat
SSV11	25 x 1"	20	44,23
SSV12	32 x 1"	20	45,70

**PPRC Termokulp Rakorlu Vana**
**2144**



Ürün Kod	Ölçü	Ambalaj	Fiyat
PTV11	25	200	67,82
PTV12	32	100	70,77

**PPRC Kapaklı Kelepçe**
**2171**

Ürün Kod	Ölçü	Ambalaj	Fiyat
TKK10	16 mm	500	0,58
TKK11	20 mm	800	0,59
TKK12	22 mm	500	0,60
TKK13	25 mm	800	0,68
TKK14	27 mm	500	0,69
TKK15	32 mm	500	0,85
TKK16	40 mm	300	1,28
TKK17	50 mm	100	1,57

**PPRC Test Tapası**
**2163**

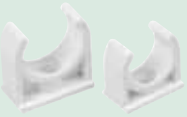
Ürün Kod	Ölçü	Ambalaj	Fiyat
DKT21	20 x 1/2"	100	0,55

**PPRC Tekli Kelepçe**
**2171**

Ürün Kod	Ölçü	Ambalaj	Fiyat
TKK01	20 mm	1000	0,38
TKK03	25 mm	800	0,45
TKK05	32 mm	500	0,52
TKK06	40 mm	300	0,94

**PPRC Çiftli Kelepçe**
**2172**

Ürün Kod	Ölçü	Ambalaj	Fiyat
CFK01	20 mm	400	0,70
CFK03	25 mm	300	0,80
CFK05	32 mm	400	0,89

**PPRC Çalparalı Çekvalf**
**2206**

Ürün Kod	Ölçü	Ambalaj	Fiyat
CKV11	20 mm	80	9,33
CKV12	25 mm	80	11,00
CKV13	32 mm	80	13,33

**PPRC Dik Yaylı Çekvalf**
**2206**

Ürün Kod	Ölçü	Ambalaj	Fiyat
CKV01	20	80	9,40
CKV02	25	80	11,20
CKV03	32	80	15,00

**PPRC Düz Radyatör Vanası**
**2163**

Ürün Kod	Ölçü	Ambalaj	Fiyat
DRV11	20 x 1/2"	80	23,30
DRV12	25 x 1/2"		25,66
DRV13	25 x 3/4"		28,31

**PPRC Köşe Radyatör Vanası**
**2164**

Ürün Kod	Ölçü	Ambalaj	Fiyat
KRV01	20 x 1/2"	60	23,30
KRV02	25 x 1/2"		25,66
KRV03	25 x 3/4"		28,31

**PPRC Bahçe Musluğu**
**2205**

Ürün Kod	Ölçü	Ambalaj	Fiyat
BMP01	20 x 1/2"		18,17





**PPRC Kombi Bağlantı Seti**
**2207**

Ürün Kod	Ölçü	Ambalaj	Fiyat
KST01	Nipelili 8 Parça	10	71,17
KST02	Dirsekli 8 Parça	10	71,17

**Yere Tespit Kroşesi**
**2311**

Ürün Kod	Ölçü	Ambalaj	Fiyat
YTK01	Kroşe	250	0,116

**Köşe Dönücü**
**2301**

Ürün Kod	Ölçü	Ambalaj	Fiyat
KSD01	Köşe Dönücü	10	0,77

**Lama ve Klips**
**2321**



Ürün Kod	Ölçü	Ambalaj	Fiyat
LAM21	Lama (2,5 m boy)	100	3,75
KLP01	Klips	500	0,15
KLM11	Klipsli Lama 33cm	500	1,00
KLM12	Klipsli Lama 50 cm	500	1,50

**PPRC Kaynak Makinası**
**2331**

Ürün Kod	Ölçü	Ambalaj	Fiyat
PTS01	Komple Takım Sandığı	1	310,34
PKM11	Kaynak Makinası	1	200,00

**Boru Makası**
**2334**

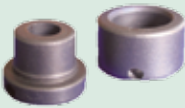
Ürün Kod	Ölçü	Ambalaj	Fiyat
PBM01	16 - 40 (manuel)	1	61,64
PBM02	16 - 40 (otomatik)	1	115,52
PBM03	63 mm	1	293,10

**Kaynak Paftası**
**2332**

Ürün Kod	Ölçü	Ambalaj	Fiyat
KPF01	20 mm	1	19,67
KPF02	25 mm	1	22,95
KPF03	32 mm	1	26,23
KPF04	40 mm	1	29,51
KPF05	50 mm	1	66,67
KPF06	63 mm	1	80,00
KPF07	75 mm	1	118,52
KPF08	90 mm	1	160,00
KPF09	110 mm	1	242,00
KPF10	125 mm	1	339,13
KPF12	160 mm	1	632,61

**Boru Soyma Aparatı**
**2333**

Ürün Kod	Ölçü	Ambalaj	Fiyat
BSA01	20 - 25 mm	1	Fiyat Sorunuz
BSA02	32 - 40 mm	1	Fiyat Sorunuz
BSA03	50 - 63 mm	1	Fiyat Sorunuz



**PE - RT Boru**
**2212**

Ürün Kod	Ölçü	Ambalaj	Fiyat
PRT01	16 x 2 mm	160	2,92

**Kırlı PE - RT Boru**
**2212**

Ürün Kod	Ölçü	Ambalaj	Fiyat
PRT21	16 x 2 mm (Kırmızı)	100	3,96
PRT22	16 x 2 mm (Mavi)	100	3,96

**PE - RT Oksijen Bariyerli Boru**
**2202**

Ürün Kod	Ölçü	Ambalaj	Fiyat
PRT11	16 x 2 mm	160	3,30

**PE - RT Oksijen Bariyerli Kırlı Boru**
**2212**

Ürün Kod	Ölçü	Ambalaj	Fiyat
PRT31	16 x 2 mm (Kırmızı)	100	4,56
PRT32	16 x 2 mm (Mavi)	100	4,56

**PE - RT Oksijen Bariyerli Boru 5 Katmanlı**
**2202**

Ürün Kod	Ölçü	Ambalaj	Fiyat
PRT12	16 x 2 mm	160	3,50

**PE - RT Oksijen Bariyerli Kırlı Boru 5 Katmanlı**
**2212**

Ürün Kod	Ölçü	Ambalaj	Fiyat
PRT33	16 x 2 mm (Kırmızı)	100	4,76
PRT34	16 x 2 mm (Mavi)	100	4,76

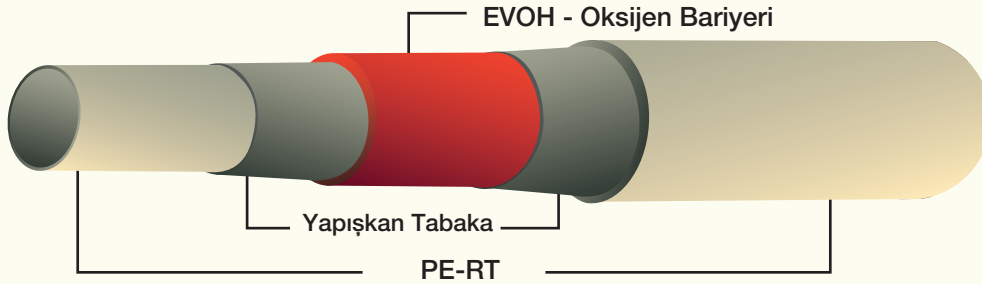

## 5 Katmanlı PE-RT Borunun avantajları;

- Oksijen geçişini önleyen bariyer,
- Kireçlenme ve korozyonu önler.
- Kolay uygulanabilir.
- Her türlü hava koşulunda uygulanabilir.
- Esnektir. Kıvrılabilir, bükülebilir.
- İstenilen renkte - metrajda üretilebilir.
- Isıya dayanıklıdır.
- Kimyasallara dayanıklıdır.
- Yüksek basınçlara dayanıklıdır.
- Hafiftir, taşınması kolaydır.
- PE-Xb'den daha esnektir.
- 5. katmanı sayesinde ekstra korunaklı.

**PPRC Yerden Isıtma Borusu**
**2203**

Ürün Kod	Ölçü	Ambalaj	Fiyat
YIB01	17 x 2 mm	160	4,01

**Spiral Hortum**
**2204**

Ürün Kod	Ölçü	Ambalaj	Fiyat
SKB01	25 mm (Kırmızı)	100	1,67
SKB02	25 mm (Mavi)	100	1,67

**PE - XB Cross - Link Boru**
**2201**

Ürün Kod	Ölçü	Ambalaj	Fiyat
PEX01	16 x 2 mm	160	4,96

**PE - XB Cross - Link Kılıflı Boru**
**2201**

Ürün Kod	Ölçü	Ambalaj	Fiyat
PEX21	16 x 2 mm (Kırmızı)	100	6,36
PEX22	16 x 2 mm (Mavi)	100	6,36

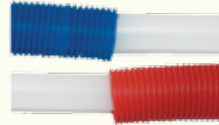

**PE - XB Cross - Link Oksijen Bariyerli Boru**
**2201**

Ürün Kod	Ölçü	Ambalaj	Fiyat
PEX11	16 x 2 mm	160	6,13

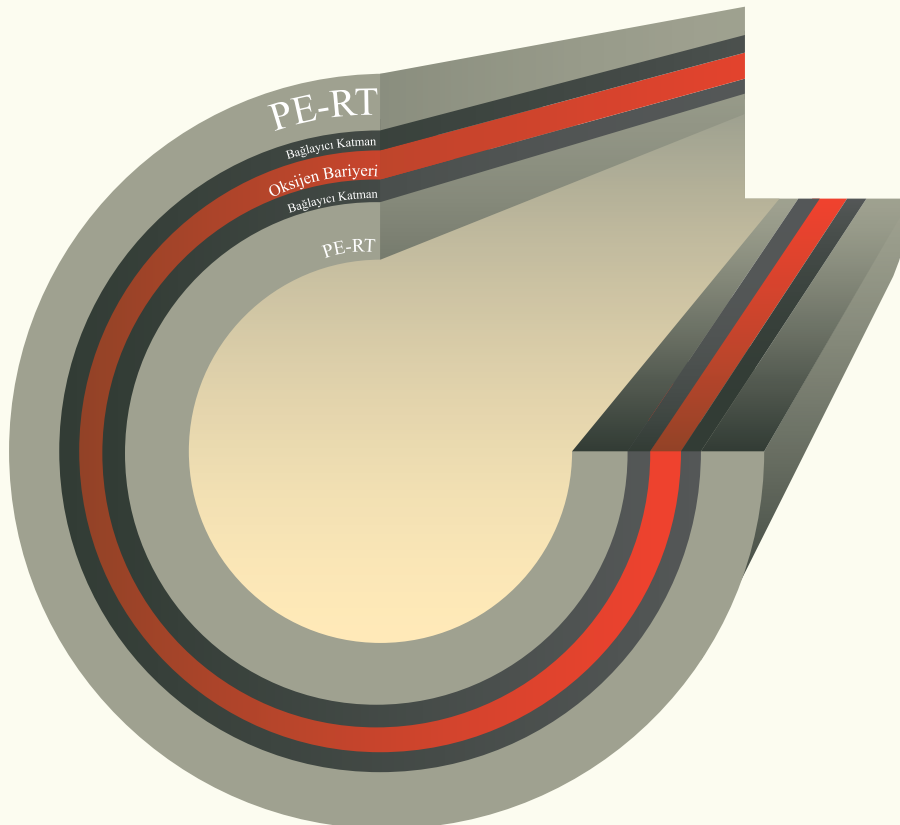
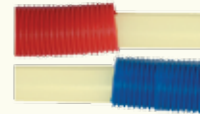

**PE - XB Cross - Link Oksijen Bariyerli Kılıflı Boru**
**2201**

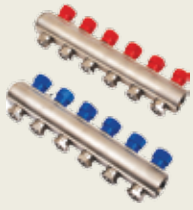
Ürün Kod	Ölçü	Ambalaj	Fiyat
PEX31	16 x 2 mm (Kırmızı)	100	7,55
PEX32	16 x 2 mm (Mavi)	100	7,55

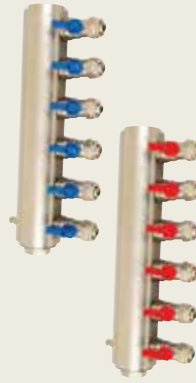

**Kendinden Vanalı Kollektör 1"**
**5411**

Ürün Kod	Ölçü	Ambalaj	Fiyat
KVK02	2	30	73,61
KVK03	3	20	110,50
KVK04	4	18	143,70
KVK05	5	16	179,54
KVK06	6	12	215,38
KVK07	7	12	251,39
KVK08	8	10	287,23
KVK09	9	10	323,24
KVK10	10	8	359,26
KVK11	11	8	395,27
KVK12	12	8	430,93
KVK13	13	8	466,95

**Kendinden Mini Vanalı Kollektör 1"**
**5412**

Ürün Kod	Ağız Sayısı	Ambalaj	Fiyat
KMV02	2	30	76,42
KMV03	3	20	114,72
KMV04	4	18	148,27
KMV05	5	16	185,51
KMV06	6	12	222,41
KMV07	7	12	259,65
KMV08	8	10	296,54
KMV09	9	10	333,78
KMV10	10	8	370,68
KMV11	11	8	408,09
KMV12	12	8	444,81
KMV13	13	8	482,23

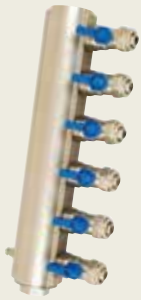
**Kendinden Mini Vanalı Kollektör 1/4"**
**5422**

Ürün Kod	Ölçü	Ambalaj	Fiyat
KMV22	2	30	151,08
KMV23	3	40	219,59
KMV24	4	18	286,35
KMV25	5	16	361,89
KMV26	6	12	426,89
KMV27	7	12	498,92
KMV28	8	10	574,46
KMV29	9	10	646,49
KMV30	10	8	727,30
KMV31	11	8	785,27
KMV32	12	8	853,78

**İç Dişli Kollektör Nikeli 1/4"**
**5402**

Ürün Kod	Ağız Sayısı	Ambalaj	Fiyat
KLK22	2	30	67,64
KLK23	3	20	97,50
KLK24	4	18	127,36
KLK25	5	16	163,38
KLK26	6	12	189,73
KLK27	7	12	223,11
KLK28	8	10	252,09
KLK29	9	10	283,72
KLK30	10	8	323,24
KLK31	11	8	354,86
KLK32	12	8	386,49

**Küresel Vana PN16 TSE TS EN 13547**
**5501**

Ürün Kod	Ölçü	Ambalaj	Fiyat
KRV11	1/4"	100	22,22
KRV12	3/8"	100	24,16
KRV13	1/2"	100	27,93
KRV14	3/4"	60	39,53
KRV15	1"	40	64,12
KRV16	1 1/4"	25	101,89
KRV17	1 1/2"	20	151,96
KRV18	2"	15	210,81
KRV19	2 1/2"	10	400,54
KRV20	3"	6	604,32
KRV21	4"	4	897,70

**By Pass Kollektörü**
**5431**

Ürün Kod	Ölçü	Ambalaj	Fiyat
BYK01	1/2 By-Pass Koll. Ayarlı Ventil	40	105,41

**Yerden Isıtma Boru Bağlantı Rakoru**
**5435**

Ürün Kod	Ölçü	Ambalaj	Fiyat
BBR01	16 x 2 İç Dişli Rakor	300	13,00
BBR11	16 x 2 Dış Dişli Rakor	300	13,00



BBR21	16 x 2 Boru Bağlantı Rakoru	300	18,01
BBR31	16 x 2 Boru Bağlantı Ek Parçası	300	20,64



BBR41	1/2" Nipel Gidiş Parçası	300	10,98
-------	--------------------------	-----	-------

**Radyatör Vanası (Geri Dönüş - PEX Vanası)**
**5520**

Ürün Kod	Ölçü	Fiyat
RVK81	1/2" Köşe Geri Dönüş Vanası	30,74
RVK82	1/2" Köşe Geri Dönüş Pex Vanası	34,78

**Radyatör Vanası**
**5520**

Ürün Kod	Ölçü	Fiyat
RVK01	1/2" Köşe Rad. Van. Eko.	27,05
RVK02	1/2" Köşe Rad. Van. Lüks	36,01
RVK03	3/4" Köşe Rad. Vanası	45,68



Ürün Kod	Ölçü	Fiyat
RVK11	1/2" Köşe Rad. Pex Boru Van.	34,78
RVK12	1/2" Köşe Rad. Bağ. Van.	34,78



Ürün Kod	Ölçü	Fiyat
RVK21	1/2" Düz Radyatör Vanası	34,78
RVK22	3/4" Düz Radyatör Vanası	57,80

**Yerden Isıtma Boru Bağlantı Dirsek Rakoru**
**5436**



Ürün Kod	Ölçü	Ambalaj	Fiyat
YED01	16 x 2 Erkek Dirsek	250	19,76
YED02	16 x 2 Eşit Dirsek	250	25,03
YED03	15 x 1 Erkek Dirsek	250	14,05

**Kollektör Parçaları**
**5430**

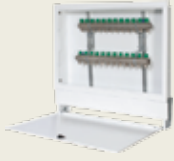
Ürün Kod	Ölçü	Fiyat
KLE01	1/4" Otomatik Purjör	57,97
KLE02	1/4" Mekanik Purjör Torbalı	5,62
KLE03	1" Kol. Kelepçesi Metal Takım	5,91
KLE05	1/8" Test Nipeli	4,83

**Kollektör Dolabı (Sıva Üstü)**
**7551**

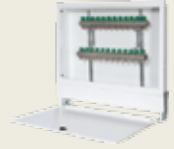
Ürün Kod	Ölçü	Ambalaj	Fiyat
KDU01	40x70x11	1	242,67
KDU02	60x70x11	1	312,00
KDU03	80x70x11	1	397,33
KDU04	100x70x11	1	454,67

**Kollektör Dolabı (Sıva Altı)**
**7552**

Ürün Kod	Ölçü	Ambalaj	Fiyat
KDA01	40x70x11	1	240,00
KDA02	60x70x11	1	304,00
KDA03	80x70x11	1	377,33
KDA04	100x70x11	1	440,00

**Eko Kollektör Dolabı**
**7550**

Ürün Kod	Ölçü	Ambalaj	Fiyat
EKD01	40x60x11	1	197,33
EKD02	60x60x11	1	282,67
EKD03	80x60x11	1	358,67

**Sac Kollektör Dolabı (Sıva Altı)**
**7553**

Ürün Kod	Ölçü	Ambalaj	Fiyat
KDS01	40x60x10	1	157,89
KDS02	60x60x10	1	189,47
KDS03	80x60x10	1	221,05

**Fleksli Bağlantı Boruları**
**3851**

Ürün Kod	Çap	Boy	Ambalaj	Fiyat
FLX01	50	35	1	9,70
FLX02	50	45	1	11,32
FLX03	50	60	1	12,94
FLX05	75	35	1	16,18
FLX06	75	45	1	19,42
FLX07	75	60	1	22,65

**Klozet Bağlantı Borusu**

Ürün Kod	Çap	Boy	Ambalaj	Fiyat
FLX10	110	30	1	24,27
FLX11	110	45	1	29,12
FLX12	110	60	1	27,50

**Polietilen Alüminyum Folyolu İzole Boru**
**3931**

Ürün Kod	Ölçü	Ambalaj	Fiyat/m
ALM01	22 / 10	240	3,33
ALM02	28 / 10	180	3,54
ALM03	35 / 10	140	4,38
ALM04	42 / 10	108	6,02
ALM05	48 / 10	90	7,16
ALM06	60 / 10	70	8,18

**Polietilen İzole Boru 10mm**
**3901**

Ürün Kod	İzole Çapı	Ambalaj	Fiyat/m
IZL01	22 mm	240	1,67
IZL02	28 mm	180	1,98
IZL03	35 mm	140	2,40
IZL04	42 mm	108	2,95
IZL05	48 mm	90	3,30
IZL06	60 mm	70	3,98
IZL07	76 mm	48	5,34
IZL08	89 mm	40	6,59
IZL09	114 mm	30	8,52

**Polietilen İzole Boru 15mm**
**3911**

Ürün Kod	İzole Çapı	Ambalaj	Fiyat/m
IZL11	22 mm	160	3,33
IZL12	28 mm	140	3,65
IZL13	35 mm	110	3,96
IZL14	42 mm	90	5,34
IZL15	48 mm	80	6,25
IZL16	60 mm	60	7,16
IZL17	76 mm	40	7,84
IZL18	89 mm	30	8,98
IZL19	114 mm	24	11,36

**Polietilen İzole Boru 20mm**
**3921**

Ürün Kod	İzole Çapı	Ambalaj	Fiyat/m
IZL21	22 mm	108	5,00
IZL22	28 mm	96	5,63
IZL23	35 mm	80	6,04
IZL24	42 mm	70	7,16
IZL25	48 mm	60	7,84
IZL26	60 mm	40	8,98
IZL27	76 mm	30	10,45
IZL28	89 mm	24	13,64
IZL29	114 mm	20	15,91

**Dirsek 90°**
**5001**
**5101**

Ölçü	Ambalaj	SİYAH		GALVANİZ	
		Kod	Fiyat	Kod	Fiyat
1/2"	300	S9001	2,62	G9001	3,51
3/4"	200	S9002	4,21	G9002	5,52
1"	120	S9003	6,58	G9003	8,11
1 1/4"	80	S9004	12,92	G9004	15,61
1 1/2"	60	S9005	21,52	G9005	25,21
2"	32	S9006	24,64	G9006	29,64

**Manşon 270**
**5021**
**5121**

Ölçü	Ambalaj	SİYAH		GALVANİZ	
		Kod	Fiyat	Kod	Fiyat
1/2"	480	S2701	3,25	G2701	3,99
3/4"	240	S2702	4,26	G2702	5,49
1"	210	S2703	5,71	G2703	7,22
1 1/4"	120	S2704	9,35	G2704	11,35
1 1/2"	80	S2705	13,08	G2705	16,35
2"	50	S2706	19,68	G2706	24,29

**Dirsek 45°**
**5002**
**5102**

Ölçü	Ambalaj	SİYAH		GALVANİZ	
		Kod	Fiyat	Kod	Fiyat
1/2"	360	S1201	9,70	G1201	12,12
3/4"	240	S1202	11,86	G1202	14,81
1"	160	S1203	18,03	G1203	22,54

**Manşon Redüksiyon**
**5022**
**5122**

Ölçü	Ambalaj	SİYAH		GALVANİZ	
		Kod	Fiyat	Kod	Fiyat
3/4" - 1/2"	320	S2401	5,66	G2401	7,15
1" - 1/2"	240	S2402	7,38	G2402	8,99
1" - 3/4"	192	S2403	6,58	G2403	8,15
1 1/4" - 1"	140	S2406	11,75	G2406	14,70

**Dirsek Redüksiyon**
**5003**
**5103**

Ölçü	Ambalaj	SİYAH		GALVANİZ	
		Kod	Fiyat	Kod	Fiyat
3/4" - 1/2"	240	S9101	6,38	G9101	7,50
1" - 1/2"	160	S9102	8,58	G9102	10,92
1" - 3/4"	140	S9103	9,35	G9103	11,47

**Kör Tapa**
**5031**
**5131**

Ölçü	Ambalaj	SİYAH		GALVANİZ	
		Kod	Fiyat	Kod	Fiyat
1/2"	540	S2901	2,27	G2901	2,80
3/4"	300	S2902	3,15	G2902	3,79
1"	160	S2903	3,53	G2903	4,14
1 1/4"	120	S2904	6,30	G2904	7,85
1 1/2"	100	S2905	7,94	G2905	9,63
2"	50	S2906	14,04	G2906	17,29

**Test Dirsek**
**5004**

Ölçü	Ambalaj	SİYAH		Fiyat
		Kod	Fiyat	
1"	120	S9302		14,60

**Inegal TE**
**5012**
**5112**

Ölçü	Ambalaj	SİYAH		GALVANİZ	
		Kod	Fiyat	Kod	Fiyat
3/4" - 1/2" - 1/2"	192	S0302	8,33	G0302	9,35
3/4" - 1/2" - 3/4"	144	S0303	7,63	G0303	8,69
3/4" - 3/4" - 1/2"	168	S0304	9,67	G0304	11,07
1" - 1/2" - 1"	120	S0308	10,09	G0308	11,35
1 1/4" - 1/2" - 1 1/4"	72	S0312	16,67	G0312	19,03
1 1/4" - 3/4" - 1 1/4"	72	S0313	18,09	G0313	20,13
1 1/4" - 1" - 1 1/4"	60	S0315	19,80	G0315	22,43
2" - 3/4" - 2"	40	S0317	42,63	G0317	49,07
1 1/2" - 1/2" - 1 1/2"	60	S0318	22,33	G0318	25,59

**Kuyruklu Dirsek**
**5005**
**5105**

Ölçü	Ambalaj	SİYAH		GALVANİZ	
		Kod	Fiyat	Kod	Fiyat
1/2"	400	S9201	3,33	G9201	4,05
3/4"	240	S9202	5,14	G9202	6,29
1"	120	S9203	8,25	G9203	10,60
1 1/4"	84	S9204	15,05	G9204	18,28
1 1/2"	56	S9205	21,99	G9205	27,43
2"	30	S9206	29,18	G9206	35,98

**TE**
**5011**
**5111**

Ölçü	Ambalaj	SİYAH		GALVANİZ	
		Kod	Fiyat	Kod	Fiyat
1/2"	240	S1301	3,78	G1301	4,68
3/4"	144	S1302	6,54	G1302	8,11
1"	72	S1303	9,41	G1303	11,86
1 1/4"	50	S1304	17,28	G1304	21,24
1 1/2"	44	S1305	26,84	G1305	32,86
2"	30	S1306	38,58	G1306	46,23

**Köşe Konik Rakoru**
**5063**
**5163**

Ölçü	Ambalaj	SİYAH		GALVANİZ	
		Kod	Fiyat	Kod	Fiyat
1/2"	120	S9601	19,91	G9601	24,11
3/4"	80	S9602	22,96	G9602	27,87
1"	60	S9603	33,11	G9603	40,07

**Nipel**
**5041**
**5141**

Ölçü	Ambalaj	SİYAH		GALVANİZ	
		Kod	Fiyat	Kod	Fiyat
1/2"	320	S2801	2,80	G2801	3,58
3/4"	360	S2802	3,78	G2802	4,68
1"	240	S2803	5,21	G2803	6,75
1 1/4"	140	S2804	9,35	G2804	11,35
1 1/2"	100	S2805	11,06	G2805	13,13
2"	50	S2806	19,31	G2806	23,65

**Kuyruklu Köşe Konik Rakor**
**5064**
**5164**

Ölçü	Ambalaj	SİYAH		GALVANİZ	
		Kod	Fiyat	Kod	Fiyat
1/2"	120	S9801	19,99	G9801	24,19
3/4"	80	S9802	25,45	G9802	30,74
1"	60	S9803	34,83	G9803	42,07

**Nipel Redüksiyon**
**5042**
**5142**

Ölçü	Ambalaj	SİYAH		GALVANİZ	
		Kod	Fiyat	Kod	Fiyat
3/4" - 1/2"	360	S0001	6,27	G0001	7,41
1" - 1/2"	200	S0002	12,21	G0002	14,90
1" - 3/4"	200	S0003	6,93	G0003	8,44
1 1/4" - 1"	120	S0006	11,45	G0006	13,40
1 1/2" - 1"	100	S0009	24,77	G0009	31,29
1 1/2" - 1 1/4"	100	S0010	13,86	G0010	16,90
2" - 1"	60	S0013	23,25	G0013	28,15
2" - 1 1/2"	60	S0015	26,39	G0015	32,03

**Kruva**
**5051**
**5151**

Ölçü	Ambalaj	SİYAH		GALVANİZ	
		Kod	Fiyat	Kod	Fiyat
1/2"	200	S1801	13,47	G1801	16,90
3/4"	180	S1802	21,10	G1802	25,28
1"	160	S1803	25,80	G1803	31,29
1 1/4"	140	S1804	34,19	G1804	42,00
1 1/2"	120	S1805	45,26	G1805	56,01
2"	100	S1806	67,37	G1806	83,58

**Redüksiyon**
**5043**
**5143**

Ölçü	Ambalaj	SİYAH		GALVANİZ	
		Kod	Fiyat	Kod	Fiyat
3/4" - 1/2"	400	S0201	2,80	G0201	3,79
1" - 1/2"	300	S0202	4,14	G0202	5,31
1" - 3/4"	300	S0203	3,78	G0203	4,94
1 1/4" - 1/2"	160	S0204	7,80	G0204	9,16
1 1/4" - 3/4"	140	S0205	6,57	G0205	8,15
1 1/4" - 1"	140	S0206	5,00	G0206	6,03
1 1/2" - 1/2"	120	S0207	9,70	G0207	12,11
1 1/2" - 3/4"	120	S0208	11,14	G0208	13,40
1 1/2" - 1"	400	S0209	7,38	G0209	8,99
1 1/2" - 1 1/4"	300	S0210	7,53	G0210	9,16
2" - 1/2"	300	S0211	19,68	G0211	24,37
2" - 3/4"	160	S0212	19,50	G0212	24,11
2" - 1"	140	S0213	16,00	G0213	19,78
2" - 1 1/4"	140	S0214	15,23	G0214	18,33
2" - 1 1/2"	120	S0215	13,68	G0215	16,90

**Pompa Bağlantı Somunu**
**5091**
**5191**

Ölçü	Ambalaj	SİYAH		GALVANİZ	
		Kod	Fiyat	Kod	Fiyat
1"	300	S3741	5,19	G3741	6,85
1 1/4"	160	S3742	8,44	G3742	11,02

**Pompa Bağlantı Rakoru**
**5092**
**5192**

Ölçü	Ambalaj	SİYAH		GALVANİZ	
		Kod	Fiyat	Kod	Fiyat
1"	400	S3721	5,39	G3721	7,80
1 1/4"	260	S3722	8,44	G3722	10,64

**Konik Rakor**
**5061**
**5161**

Ölçü	Ambalaj	SİYAH		GALVANİZ	
		Kod	Fiyat	Kod	Fiyat
1/2"	120	S3401	15,12	G3401	18,02
3/4"	80	S3402	17,07	G3402	20,43
1"	60	S3403	19,89	G3403	23,55
1 1/4"	60	S3404	32,76	G3404	40,52
1 1/2"	40	S3405	38,47	G3405	47,45
2"	30	S3406	63,07	G3406	78,05

**Kuyruklu Konik Rakor**
**5062**
**5162**

Ölçü	Ambalaj	SİYAH		GALVANİZ	
		Kod	Fiyat	Kod	Fiyat
1/2"	120	S3411	14,70	G3411	17,54
3/4"	80	S3412	17,78	G3412	21,24
1"	60	S3413	21,98	G3413	26,31
1 1/4"	60	S3414	34,72	G3414	41,82
1 1/2"	40	S3415	44,38	G3415	53,61
2"	30	S3416	70,84	G3416	85,53

**Boru Atlama**
**5071**
**5171**

Ölçü	Ambalaj	SİYAH		GALVANİZ	
		Kod	Fiyat	Kod	Fiyat
1/2"	100	S8501	11,47	G8501	14,32
3/4"	80	S8502	17,46	G8502	21,63
1"	50	S8503	34,68	G8503	44,95

**Deve Boynu**
**5081**
**5181**

Ölçü	Ambalaj	SİYAH		GALVANİZ	
		Kod	Fiyat	Kod	Fiyat
1/2"	200	S0101	7,85	G0101	9,91
3/4"	160	S0102	13,68	G0102	17,29
1"	120	S0103	18,45	G0103	23,46
1 1/4"	100	S0104	32,65	G0104	40,52
1 1/2"	80	S0105	42,07	G0105	53,61
2"	60	S0106	69,75	G0106	86,45

**Yeşil Emici**
**3081**

Ürün Kod	Ölçü	Ambalaj	Fiyat
YEH03	1"	24	8,89
YEH04	1 1/4"	24	12,32
YEH05	1 1/2"	24	16,42
YEH06	2"	24	25,32
YEH07	2 1/2"	24	37,63
YEH08	3"	24	49,61
YEH09	3 1/2"	24	63,68
YEH10	4"	24	80,33
YEH11	5"	24	124,34
YEH12	6"	24	162,84
YEH13	8"	24	283,78

**Sarı Emici**
**3082**

Ürün Kod	Ölçü	Ambalaj	Fiyat
SEH23	1"	24	8,13
SEH24	1 1/4"	24	11,16
SEH25	1 1/2"	24	13,95
SEH26	2"	24	22,96
SEH27	2 1/2"	24	32,89
SEH28	3"	24	43,27
SEH29	3 1/2"	24	62,33
SEH30	4"	24	71,58

**Şeffaf Spiral**
**3091**

Ürün Kod	Ölçü	Ambalaj	Fiyat
SFH03	1"	50	4,50
SFH04	1 1/7"	50	5,19
SFH05	1 1/4"	50	5,84
SFH06	1 1/2"	50	8,31
SFH07	2"	50	12,41

**Klima Hortumu**
**3092**

Ürün Kod	Ölçü	Ambalaj	Fiyat
SFH01	5/8"	50	2,70
SFH02	3/4"	50	3,78

**Patoz ve Kırmızı Verici**
**3083**

Ürün Kod	Ölçü	Ambalaj	Fiyat
KEH44	1 1/4"	24	7,52
KEH45	1 1/2"	24	11,21
KEH46	2"	24	16,82
KEH47	2 1/2"	24	26,16
KEH48	3"	24	35,87
KEH49	3 1/2"	24	44,30
KEH50	4"	24	53,62
KEH51	5"	24	76,32
KEH52	6"	24	106,73
KEH53	8"	24	158,11

**Jakuzi Hortumu**
**3093**

Ürün Kod	Ölçü	Ambalaj	Fiyat
JKH23	1"	50	9,24
JKH24	1 1/7"	50	10,66
JKH25	1 1/4"	50	12,08
JKH26	1 1/2"	50	16,64
JKH27	2"	50	27,50

**Gri Toz Verici**
**3084**

Ürün Kod	Ölçü	Ambalaj	Fiyat
GVH64	1 1/4"	50	7,34
GVH65	1 1/2"	50	11,42
GVH66	2"	50	16,32
GVH67	2 1/2"	25	20,39
GVH68	3"	25	30,59
GVH69	3 1/2"	25	35,61
GVH70	4"	25	42,11
GVH71	5"	25	69,19
GVH72	6"	25	89,19
GVH73	8"	25	127,46





**Eko Örgülü Hortum**
**3001**

Ürün Kod	Ölçü	Ambalaj	Fiyat
EOH01	1/2"	100	2,49
EOH02	5/8"	100	3,62
EOH03	3/4"	100	4,18
EOH04	1"	50	7,08
EOH05	1 1/4"	50	10,99

**Kalın Örgülü Hortum**
**3002**

Ürün Kod	Ölçü	Ambalaj	Fiyat
KOH01	1/2"	100	4,15
KOH02	5/8"	100	5,68
KOH03	3/4"	100	7,96
KOH04	1"	50	11,08
KOH05	1 1/4"	50	17,31

**Meteor Örgülü Hortum**
**3003**

Ürün Kod	Ölçü	Ambalaj	Fiyat
MOH01	1/2"	100	2,49
MOH02	5/8"	100	3,62
MOH03	3/4"	100	4,18
MOH04	1"	50	7,08
MOH05	1 1/4"	50	10,99

**Örgülü Soft Hortum**
**3013**

Ürün Kod	Ölçü	Ambalaj	Fiyat
OSH01	1/2"	100	3,76
OSH02	5/8"	100	5,59
OSH03	3/4"	100	6,58
OSH04	1"	50	9,41

**Eko Soft Hortum**
**3011**

Ürün Kod	Ölçü	Ambalaj	Fiyat
ESH01	1/2"	100	3,74
ESH02	5/8"	100	5,59
ESH03	3/4"	100	6,78
ESH04	1"	50	10,64

**Süper Soft Hortum**
**3012**

Ürün Kod	Ölçü	Ambalaj	Fiyat
SSH01	1/2"	100	4,72
SSH02	5/8"	100	5,92
SSH03	3/4"	100	7,54
SSH04	1"	50	11,94
SSH05	1 1/4"	50	18,31
SSH06	1 1/2"	50	23,87

**Şeffaf Bahçe Hortumu**
**3051**

Ürün Kod	Ölçü	Ambalaj	Fiyat/m
SBH01	1/2"	100	4,84
SBH02	5/8"	100	6,04
SBH03	3/4"	100	8,38
SBH04	1"	50	12,25
SBH05	1 1/4"	50	15,43
SBH06	1 1/2"	50	19,16

**Market Tipi Hortumlar**
**3071**

Ürün Kod	Ölçü	Ambalaj	Fiyat/Adet
MTH01	1/2" Süper Soft	25	122,16
MTH02	1/2" Meteor	25	67,18
MTH03	1/2" Kalın Örgülü	25	94,05
MTH04	1/2" Eko Soft	25	99,75
MTH05	1/2" Süper Garden	25	101,68
MTH06	1/2" Eko Örgülü	25	70,84
MTH10	1/2" Örgülü Soft	25	103,89
MTH20	1/2" Gardeno	25	86,66

**Şeffaf Milimetrik Hortum (Terazi)**
**3061**

Ürün Kod	Ölçü	Ambalaj	Fiyat/m
SMH06	6 mm	100	1,43
SMH08	8 mm	100	1,71
SMH10	10 mm	100	2,05

**Süper Garden Hortum**
**3031**

Ürün Kod	Ölçü	Ambalaj	Fiyat
SGH01	1/2"	100	3,81
SGH02	5/8"	100	4,59
SGH03	3/4"	100	7,04
SGH04	1"	50	10,42
SGH05	1 1/4"	50	14,57

**Soft Garden Hose**
**3051**

Ürün Kod	Ölçü	Ambalaj	Fiyat/m
SBH11	1/2"	100	3,19

**Super Soft Garden Hose**
**3051**



Ürün Kod	Ölçü	Ambalaj	Fiyat/m
SBH21	1/2"	100	3,99

**Soft Garden Hose Market Tipi**
**3071**

Ürün Kod	Ölçü	Ambalaj	Fiyat/m
MTH12	1/2"	25	84,43

**Super Soft Garden Hose Market Tipi**
**3071**

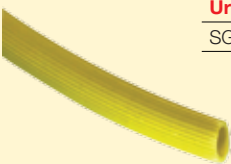
Ürün Kod	Ölçü	Ambalaj	Fiyat/m
MTH13	1/2"	25	102,60

**Super Gardeno Hortum**
**3025**

Ürün Kod	Ölçü	Ambalaj	Fiyat/m
SGO12	1/2"	100	3,47

**Süper Yellow & Black Garden Hose**
**3022**

Ürün Kod	Ölçü	Ambalaj	Fiyat/mt
SYB11	1/2"	100	3,39

**Süper Green & Black Garden Hose**
**3022**



Ürün Kod	Ölçü	Ambalaj	Fiyat/mt
SYB21	1/2"	100	3,39

**Süper Blue & Black Garden Hose**
**3022**

Ürün Kod	Ölçü	Ambalaj	Fiyat/mt
SYB31	1/2"	100	3,39

**Süper Red & Black Garden Hose**
**3022**

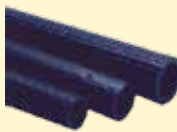
Ürün Kod	Ölçü	Ambalaj	Fiyat/mt
SYB41	1/2"	100	3,39

**Süper Tulpan Hortum**
**3022**

Ürün Kod	Ölçü	Ambalaj	Fiyat
STH01	1/2"	100	3,66
STH02	5/8"	100	4,36
STH03	3/4"	100	5,85
STH04	1"	50	8,78
STH05	1 1/4"	50	12,56
STH06	1 1/2"	50	15,75

**Süper Garden Hose Market Tipi 25 mt**
**3071**

Ürün Kod	Ölçü	Ambalaj	Fiyat/mt
MTH08	1/2" Süper Thermo Market Tipi	25	81,64
MTH14	1/2" Süper Yellow Garden Hose Market Tipi	25	87,09
MTH15	1/2" Süper Green Garden Hose Market Tipi	25	87,09
MTH16	1/2" Süper Blue Garden Hose Market Tipi	25	87,09
MTH17	1/2" Süper Red Garden Hose Market Tipi	25	87,09

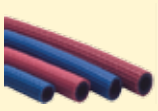

**Oksijen - Asetilen Hortumları**
**3101**

Ürün Kod	Ölçü	Ambalaj	Fiyat
OAH06	6 mm	100	4,85
OAH08	8 mm	100	5,80
OAH10	10 mm	100	6,26

**Çamaşır Makinası Temiz Su Bağlantısı**
**3121**

Ürün Kod	Ölçü	Ambalaj	Fiyat
CBH01	1,5 m. Temiz Su Bağlantı	40	9,39
CBH02	2 m. Temiz Su Bağlantı	40	10,91
CBH03	2,5 m. Temiz Su Bağlantı	20	12,42
CBH04	3 m. Temiz Su Bağlantı	20	13,94
CBH05	4 m. Temiz Su Bağlantı	20	18,06
CBH06	5 m. Temiz Su Bağlantı	20	21,64

**Tüpgaz Hortumları**
**3111**

Ürün Kod	Ölçü	Ambalaj	Fiyat
TPG08	8 mm Mavi	50	4,64
TPG10	10 mm Beyaz	50	5,30
SFB18	8 mm Şofben	100	3,50

**Çamaşır Makine Tahliye Hortumu**
**3122**

Ürün Kod	Ölçü	Ambalaj	Fiyat
CTH01	1,5 m. Tahliye Hortumu	100	5,00
CTH02	2 m. Tahliye Hortumu	100	5,71
CTH03	3 m. Tahliye Hortumu	100	6,97

**3. Sınıf Siyah Polietilen Kangal Boru 6 ATÜ**
**3221**

Ürün Kod	Ölçü	Fiyat
SPK01	20	1,07
SPK02	25	1,45
SPK03	32	1,94
SPK04	40	2,90
SPK05	50	3,87
SPK06	63	5,81
SPK07	75	7,98
SPK08	90	12,10

**3. Sınıf Siyah Polietilen Kangal Boru 10 ATÜ**
**3122**

Ürün Kod	Ölçü	Fiyat
SPK11	20	1,42
SPK12	25	1,94
SPK13	32	2,90
SPK14	40	3,87
SPK15	50	5,81
SPK16	63	7,74
SPK17	75	11,84
SPK18	90	15,73
SPK19	110	24,19

**PE 32 Yumuşak Polietilen Kangal Boru 6 ATÜ**
**3221**

Ürün Kod	Ölçü	Fiyat
YPE01	20	4,04
YPE02	25	6,13
YPE03	32	10,11
YPE04	40	15,49
YPE05	50	24,16

**PE 32 Yumuşak Polietilen Kangal Boru 10 ATÜ**
**3221**

Ürün Kod	Ölçü	Fiyat
YPE11	20	5,38
YPE12	25	8,33
YPE13	32	13,58
YPE14	40	21,55
YPE15	50	33,66

**Kaplin Manşon****6001****6101**

Ölçü	Ambalaj	SİYAH		MAVİ	
		Kod	Fiyat	Kod	Fiyat
20	100	KBM01	2,27	KBM11	2,60
25	65	KBM02	2,91	KBM12	3,76
32	50	KBM03	4,01	KBM13	5,25
40	25	KBM04	6,36	KBM14	8,35
50	15	KBM05	9,69	KBM15	12,40
63	10	KBM06	14,64	KBM16	18,91
75	6	KBM07	28,13	KBM17	35,80
90	4	KBM08	41,58	KBM18	52,88
110	3	KBM09	65,62	KBM19	81,35

**Kaplin Dirsek****6011****6111**

Ölçü	Ambalaj	SİYAH		MAVİ	
		Kod	Fiyat	Kod	Fiyat
20	100	KBD01	2,48	KBD11	3,06
25	70	KBD02	3,24	KBD12	3,92
32	50	KBD03	4,96	KBD13	5,86
40	25	KBD04	8,28	KBD14	10,03
50	15	KBD05	11,83	KBD15	14,84
63	8	KBD06	18,73	KBD16	22,56
75	6	KBD07	33,85	KBD17	42,05
90	3	KBD08	49,31	KBD18	62,90
110	2	KBD09	76,03	KBD19	95,37

**Kaplin Dirsek (İç Dişli)****6012****6112**

Ölçü	Ambalaj	SİYAH		MAVİ	
		Kod	Fiyat	Kod	Fiyat
20 x 1/2"	125	KBA01	1,82	KBB01	2,12
20 x 3/4"	125	KBA02	1,82	KBB02	2,12
25 x 1/2"	70	KBA03	2,51	KBB03	3,00
25 x 3/4"	70	KBA04	2,51	KBB04	3,00
25 x 1"	70	KBA05	2,51	KBB05	3,00
32 x 1/2"	50	KBA06	3,71	KBB06	4,60
32 x 3/4"	50	KBA07	3,71	KBB07	4,60
32 x 1"	50	KBA08	3,71	KBB08	4,60
40 x 1"	40	KBA09	10,68	KBB09	12,76
40 x 1 1/4"	25	KBA10	6,29	KBB10	7,59
50 x 1 1/4"	20	KBA11	15,65	KBB11	20,15
50 x 1 1/2"	15	KBA12	9,13	KBB12	12,37
50 x 2"	20	KBA13	15,65	KBB13	20,15
63 x 1 1/2"	10	KBA14	15,64	KBB14	18,56
63 x 2"	10	KBA15	15,64	KBB15	18,56
75 x 2"	8	KBA16	42,66	KBB16	56,35
75 x 2 1/2"	7	KBA17	25,74	KBB17	33,13
75 x 3"	8	KBA18	42,66	KBB18	56,35
90 x 2 1/2"	5	KBA19	56,82	KBB19	88,67
90 x 3"	4	KBA20	35,42	KBB20	41,49
90 x 4"	5	KBA21	56,82	KBB21	88,67

**Kaplin Dirsek (Dış Dişli)****6013****6113**

Ölçü	Ambalaj	SİYAH		MAVİ	
		Kod	Fiyat	Kod	Fiyat
20 x 1/2"	125	KBC01	1,79	KBE01	2,04
20 x 3/4"	125	KBC02	1,79	KBE02	2,04
25 x 1/2"	70	KBC03	2,51	KBE03	2,97
25 x 3/4"	70	KBC04	2,51	KBE04	2,97
25 x 1"	70	KBC05	2,51	KBE05	2,97
32 x 3/4"	50	KBC07	3,71	KBE07	4,42
32 x 1"	50	KBC08	3,71	KBE08	4,42
40 x 1"	40	KBC09	9,99	KBE09	12,02
40 x 1 1/4"	25	KBC10	6,29	KBE10	7,56
50 x 1 1/2"	15	KBC12	9,13	KBE12	12,27
63 x 2"	10	KBC15	15,64	KBE15	17,66
75 x 2"	8	KBC16	39,87	KBE16	48,28
75 x 2 1/2"	7	KBC17	25,74	KBE17	32,45
75 x 3"	8	KBC18	39,87	KBE18	48,28
90 x 2 1/2"	5	KBC19	53,10	KBE19	80,48
90 x 3"	4	KBC20	35,42	KBE20	41,31
90 x 4"	5	KBC21	53,10	KBE21	80,48

**Kaplin Adaptör (Dış Dişli)****6022****6122**

Ölçü	Ambalaj	SİYAH		MAVİ	
		Kod	Fiyat	Kod	Fiyat
20 x 1/2"	200	KBH01	1,29	KBJ01	1,44
20 x 3/4"	200	KBH02	1,29	KBJ02	1,44
25 x 1/2"	140	KBH03	1,74	KBJ03	2,02
25 x 3/4"	140	KBH04	1,74	KBJ04	2,02
25 x 1"	140	KBH05	1,74	KBJ05	2,02
32 x 3/4"	100	KBH07	2,53	KBJ07	3,02
32 x 1"	100	KBH08	2,53	KBJ08	3,02
32 x 1 1/4"	100	KBH09	2,53	KBJ09	3,08
40 x 1"	45	KBH11	3,81	KBJ11	4,76
40 x 1 1/4"	45	KBH12	3,81	KBJ12	4,76
40 x 1 1/2"	60	KBH13	5,30	KBJ13	7,07
50 x 1 1/2"	25	KBH15	6,21	KBJ15	7,31
50 x 2"	25	KBH16	6,21	KBJ16	7,31
63 x 2"	15	KBH18	9,54	KBJ18	10,94
75 x 2 1/2"	9	KBH20	16,81	KBJ20	19,42
90 x 3"	6	KBH23	26,87	KBJ23	32,37
110 x 4"	4	KBH26	41,31	KBJ26	49,70

**Kaplin Adaptör (İç Dişli)****6021****6121**

Ölçü	Ambalaj	SİYAH		MAVİ	
		Kod	Fiyat	Kod	Fiyat
20 x 1/2"	200	KBF01	1,29	KBG01	1,53
25 x 1/2"	120	KBF03	1,74	KBG03	2,05
25 x 3/4"	120	KBF04	1,74	KBG04	2,05
25 x 1"	100	KBF05	1,74	KBG05	2,05
32 x 1/2"	100	KBF06	3,65	KBG06	4,78
32 x 3/4"	80	KBF07	2,53	KBG07	3,02
32 x 1"	80	KBF08	2,53	KBG08	3,02
40 x 3/4"	35	KBF10	3,82	KBG10	4,76
40 x 1"	35	KBF11	3,82	KBG11	4,76
40 x 1 1/4"	35	KBF12	3,82	KBG12	4,76
50 x 1 1/4"	25	KBF14	6,39	KBG14	7,31
50 x 1 1/2"	25	KBF15	6,39	KBG15	7,31
63 x 2"	15	KBF18	9,63	KBG18	10,94
75 x 2"	9	KBF19	17,03	KBG19	19,42
75 x 2 1/2"	9	KBF20	17,03	KBG20	19,42
90 x 2 1/2"	7	KBF22	39,81	KBG22	47,09
90 x 3"	6	KBF23	27,42	KBG23	32,37
110 x 3"	4	KBF25	42,07	KBG25	49,70
110 x 4"	4	KBF26	42,07	KBG26	49,70

**Kaplin Dişli Te (Dış Dişli)**
**6033**
**6133**

Ölçü	Ambalaj	SİYAH		MAVİ	
		Kod	Fiyat	Kod	Fiyat
20 x 1/2" x 20	65	KBP01	2,99	KBS01	3,79
20 x 3/4" x 20	65	KBP02	2,99	KBS02	3,79
25 x 1/2" x 25	50	KBP03	4,01	KBS03	4,62
25 x 3/4" x 25	50	KBP04	4,01	KBS04	4,62
32 x 3/4" x 32	30	KBP07	5,77	KBS07	7,31
32 x 1" x 32	30	KBP08	5,77	KBS08	7,31
40 x 1" x 40	25	KBP10	13,34	KBS10	19,68
40 x 1 1/4" x 40	15	KBP11	9,34	KBS11	11,49
50 x 1 1/4" x 50	15	KBP13	21,15	KBS13	28,97
50 x 1 1/2" x 50	10	KBP14	13,60	KBS14	16,90
63 x 1 1/2" x 63	8	KBP16	29,51	KBS16	37,71
63 x 2" x 63	6	KBP17	20,86	KBS17	25,33
75 x 2" x 75	5	KBP18	71,65	KBS18	88,52
75 x 2 1/2" x 75	4	KBP19	38,30	KBS19	45,98
90 x 2 1/2" x 90	2	KBP20	100,99	KBS20	120,86
90 x 3" x 90	2	KBP21	60,91	KBS21	75,43
110 x 3" x 110	1	KBP22	84,09	KBS22	102,03
110 x 4" x 110	1	KBP23	84,09	KBS23	102,03

**Kaplin Dişli TE (İç Dişli)**
**6032**
**6132**

Ölçü	Ambalaj	SİYAH		MAVİ	
		Kod	Fiyat	Kod	Fiyat
20 x 1/2" x 20	65	KBL01	3,11	KBN01	4,00
25 x 1/2" x 25	50	KBL03	4,09	KBN03	4,80
25 x 3/4" x 25	50	KBL04	4,09	KBN04	4,80
32 x 1/2" x 32	30	KBL06	6,06	KBN06	7,71
32 x 3/4" x 32	30	KBL07	6,06	KBN07	7,71
32 x 1" x 32	30	KBL08	6,06	KBN08	7,71
40 x 3/4" x 40	15	KBL09	9,65	KBN09	12,04
40 x 1" x 40	15	KBL10	9,65	KBN10	12,04
40 x 1 1/4" x 40	15	KBL11	9,65	KBN11	12,04
50 x 1" x 50	15	KBL12	22,18	KBN12	31,35
50 x 1 1/4" x 50	10	KBL13	13,88	KBN13	17,90
50 x 1 1/2" x 50	10	KBL14	13,88	KBN14	17,90
63 x 1 1/4" x 63	8	KBL15	30,92	KBN15	41,86
63 x 1 1/2" x 63	6	KBL16	20,69	KBN16	26,68
63 x 2" x 63	6	KBL17	20,69	KBN17	26,68
75 x 2" x 75	5	KBL18	71,65	KBN18	86,53
75 x 2 1/2" x 75	4	KBL19	39,10	KBN19	47,87
90 x 2 1/2" x 90	2	KBL20	100,99	KBN20	120,71
90 x 3" x 90	2	KBL21	60,88	KBN21	60,07
110 x 3" x 110	1	KBL22	84,67	KBN22	108,32
110 x 4" x 110	1	KBL23	84,67	KBN23	108,32

**Kaplin Te**
**6031**
**6131**

Ölçü	Ambalaj	SİYAH		MAVİ	
		Kod	Fiyat	Kod	Fiyat
20	65	KBT01	3,55	KBT11	4,31
25	40	KBT02	4,65	KBT12	5,72
32	25	KBT03	6,76	KBT13	8,34
40	15	KBT04	11,59	KBT14	14,85
50	10	KBT05	16,35	KBT15	20,74
63	6	KBT06	26,10	KBT16	33,03
75	4	KBT07	44,35	KBT17	56,60
90	2	KBT08	67,45	KBT18	86,84
110	1	KBT09	109,28	KBT19	140,05

**Kaplin Redüksiyon**
**6041**
**6141**

Ölçü	Ambalaj	SİYAH		MAVİ	
		Kod	Fiyat	Kod	Fiyat
25 x 20	70	KBR01	3,39	KBR31	3,78
32 x 20	70	KBR02	4,07	KBR32	4,62
32 x 25	50	KBR03	4,07	KBR33	5,11
40 x 25	35	KBR05	6,21	KBR35	7,77
40 x 32	35	KBR06	6,21	KBR36	7,94
50 x 32	20	KBR08	10,06	KBR38	12,74
50 x 40	20	KBR09	10,06	KBR39	12,90
63 x 40	10	KBR12	12,80	KBR42	15,82
63 x 50	10	KBR13	12,80	KBR43	15,82
75 x 63	6	KBR17	23,15	KBR47	29,31
90 x 63	4	KBR18	34,48	KBR48	43,06
90 x 75	4	KBR19	34,48	KBR49	43,06

**Kaplin İnegal Te**
**6034**
**6134**

Ölçü	Ambalaj	SİYAH		MAVİ	
		Kod	Fiyat	Kod	Fiyat
25 x 20 x 25	60	KIN01	5,26	KIN21	6,64
32 x 20 x 32	25	KIN02	6,97	KIN22	8,40
32 x 25 x 32	25	KIN03	7,06	KIN23	8,52
40 x 25 x 40	15	KIN04	10,69	KIN24	13,02
40 x 32 x 40	15	KIN05	10,69	KIN25	13,02
50 x 32 x 50	10	KIN06	16,93	KIN26	20,66
50 x 40 x 50	10	KIN07	16,93	KIN27	20,66
63 x 25 x 63	6	KIN08	23,75	KIN28	28,12
63 x 32 x 63	6	KIN09	23,75	KIN29	28,29
63 x 40 x 63	6	KIN10	23,75	KIN30	28,42
63 x 50 x 63	6	KIN11	23,75	KIN31	28,63
75 x 50 x 75	4	KIN12	45,26	KIN32	54,40
75 x 63 x 75	4	KIN13	45,26	KIN33	55,19
90 x 63 x 90	2	KIN14	70,05	KIN34	80,43
90 x 75 x 90	2	KIN15	70,05	KIN35	81,24
110 x 63 x 110	1	KIN16	121,28	KIN36	120,87
110 x 75 x 110	1	KIN17	108,05	KIN37	121,63
110 x 90 x 110	1	KIN18	108,05	KIN38	122,21

**Kaplin Tapa**
**6051**
**6151**

Ölçü	Ambalaj	SİYAH		MAVİ	
		Kod	Fiyat	Kod	Fiyat
20	150	KKT01	1,28	KKT11	1,58
25	125	KKT02	1,71	KKT12	2,20
32	90	KKT03	2,48	KKT13	2,96
40	50	KKT04	3,91	KKT14	4,74
50	35	KKT05	5,86	KKT15	7,34
63	20	KKT06	9,38	KKT16	11,36
75	10	KKT07	16,88	KKT17	20,68
90	6	KKT08	24,89	KKT18	31,33
110	4	KKT09	40,53	KKT19	49,44

**Kızaklı Priz Kolye**
**6062**

Kod	Ölçü	Ambalaj	Fiyat
KKK01	32 x 1/2"	125	2,74
KKK02	32 x 3/4"	125	2,74
KKK03	40 x 1/2"	60	3,29
KKK04	40 x 3/4"	60	3,29
KKK05	50 x 1/2"	45	4,55
KKK06	50 x 3/4"	45	4,55
KKK07	63 x 1/2"	30	5,44
KKK08	63 x 3/4"	30	5,44
KKK09	63 x 1"	30	7,76
KKK10	90 x 1/2"	15	13,38
KKK11	90 x 3/4"	15	13,38
KKK12	90 x 1"	15	13,38

**Priz Kolye**
**6061**

Kod	Ölçü	Ambalaj	Fiyat
KBK01	32 x 1/2"	100	4,03
KBK02	32 x 3/4"	100	4,03
KBK03	40 x 1/2"	65	4,71
KBK04	40 x 3/4"	65	4,71
KBK05	50 x 1/2"	60	7,06
KBK06	50 x 3/4"	60	7,06
KBK07	50 x 1"	60	7,06
KBK08	63 x 1/2"	50	9,06
KBK09	63 x 3/4"	50	9,06
KBK10	63 x 1"	50	9,06
KBK13	75 x 1/2"	35	10,64
KBK14	75 x 3/4"	35	10,64
KBK15	75 x 1"	35	10,64
KBK19	90 x 1/2"	25	12,00
KBK20	90 x 3/4"	25	12,00
KBK21	90 x 1"	25	12,00
KBK22	90 x 1 1/4"	25	14,02
KBK23	90 x 1 1/2"	25	14,02
KBK25	110 x 1/2"	20	14,40
KBK26	110 x 3/4"	20	14,40
KBK27	110 x 1"	20	14,40
KBK28	110 x 1 1/4"	20	15,68
KBK29	110 x 1 1/2"	20	15,68
KBK31	125 x 1/2"	10	23,50
KBK32	125 x 3/4"	10	23,50
KBK33	125 x 1"	15	16,40
KBK34	125 x 1 1/4"	15	16,40
KBK35	125 x 1 1/2"	15	16,40

**Çöp Konteynerleri (Gri, Yeşil, Mavi, Sarı)**
**3541**

Ürün Kod	Ölçü	Ambalaj	Fiyat
CPK02 (ithal)	120 lt.	1	324,61
CPK03 (ithal)	240 lt.	1	446,33
CPK11 (ithal)	100 lt.	1	200,00
CPK12 (ithal)	120 lt.	1	233,33
CPK13 (ithal)	240 lt.	1	383,33

**Sıva ve Alçı Teknesi (25lt)**
**3551**

Ürün Kod	Ölçü	Ambalaj	Fiyat
SAT01	62x43x17	1	43,91

**Su Tutucu Bant**
**4953**

Ürün Kod	Ölçü	Ambalaj	Fiyat
STB20	AK 20 / 3	20	29,41

**Kada**
**1070**

Ürün Kod	Ölçü	Ambalaj	Fiyat
KAD01	110	36	8,00



**Mini Küresel Vana**
**3341**

Ürün Kod	Ölçü	Ambalaj	Fiyat
DMV16	16 x 16	100	2,08
DMV20	20 x 20	100	2,29

**Damlama Ekleme Nipel**
**3331**

Ürün Kod	Ölçü	Ambalaj	Fiyat
DEN16	16 x 16	500	0,17
DEN20	20 x 20	500	0,21

**Damlama Nipel Dirsek**
**3311**

Ürün Kod	Ölçü	Ambalaj	Fiyat
DND16	16 x 16	250	0,50
DND20	20 x 20	250	0,62

**Damlama Nipel TE**
**3321**

Ürün Kod	Ölçü	Ambalaj	Fiyat
DNT16	16 x 16	250	0,58
DNT20	20 x 20	250	0,62

**Damlama Çıkış Nipel**
**3332**

Ürün Kod	Ölçü	Ambalaj	Fiyat
DCN16	16 x 16	500	0,19
DCN20	20 x 20	500	0,23

**Boru Sabitleme Kazığı**
**3381**

Ürün Kod	Ölçü	Ambalaj	Fiyat
BSK01	16 x 20	250	0,62

**PVC Uzatma Borusu**
**3641**

Ürün Kod	Ölçü	Ambalaj	Fiyat
PUB01	25 cm 1"	1	3,54
PUB02	35 cm 1"	1	4,37
PUB03	50 cm 1"	1	5,83
PUB04	1 m 1"	1	11,65
PUB05	2 m 1"	1	22,89

**Yağmurlama Başlıkları**
**3611**

YGM01

Ürün Kod	Ölçü	Ambalaj	Fiyat
YGM01	B/2 Açılı Yağ. Baş. 1 1/2"	1	301,76
YGM02	B/2 Açısız Yağ. Baş. 1 1/2"	1	280,95
YGM03	A/2 Metal Yağ. Baş. 1"	1	74,92
YGM04	A/4 Plastik Yağ. Baş. 3/4"	1	18,52
YGM05	A/1 Yağ. Baş. 1"	1	18,52
AYB50	Atılğan Yağ. Baş. 1 1/2"	1	347,54



YGM02



AYB50



YGM05



YGM03

**Damlama Gözlük Kör Tapa**
**3352**

Ürün Kod	Ölçü	Ambalaj	Fiyat
DGT16	16 x 16	500	0,19
DGT20	20 x 20	500	0,23

**Damlama Kör Tapa**
**3351**

Ürün Kod	Ölçü	Ambalaj	Fiyat
DKT16	16 x 16	1.000	0,17
DKT20	20 x 20	500	0,23

**PE Damlama Kelepçe**
**3385**

Ürün Kod	Ölçü	Ambalaj	Fiyat
DPK16	16 x 16	1000	0,29
DPK20	20 x 20	500	0,37

**Pipo Dirsek**
**3312**

Ürün Kod	Ölçü	Ambalaj	Fiyat
DPD01	16 x 1/2"	150	0,58
DPD02	16 x 3/4"	250	0,58
DPD03	20 x 1/2"	250	0,73
DPD04	20 x 3/4"	250	0,73

**Grommet Conta**
**3361**

Ürün Kod	Ölçü	Ambalaj	Fiyat
DGC01	Ø16 Şeffaf Kanallı Konik	500	0,51
DGC02	Ø16 Şeffaf Kanallı Bombeli	500	0,51
DGC03	Ø16 Şeffaf Düz	500	0,51

**Debi Ayarlı Damlatıcı**
**3371**

Ürün Kod	Ölçü	Ambalaj	Fiyat
DAD01	70 lt/h	1000	0,33
DAD02	100 lt/h	500	0,42
DAD03	150 lt/h	500	0,77

**Bahçe Çim Sulama Yağmurlama Başlığı**
**3621**

Ürün Kod	Ölçü	Fiyat
BCS01	1/2"	62,43

**Pop-Up Spray Başlık**
**3631**

Ürün Kod	Ölçü	Fiyat
POP01	Pop-Up Spray Başlık	18,73

**Şanzımanlı Ekipmanlar**
**3601**

Ürün Kod	Ölçü	Ambalaj	Fiyat
YRS30	1 1/2" (Roket 30)	1	2.393,24
YRS40	2" (Roket 40)	1	3.329,73
YRS50	2" (Roket 50)	1	3.954,05

**14" Jumbo Dikdörtgen Vana Kutusu**
**6070**

Ürün Kod	Ebat	Ambalaj	Fiyat
VNK04	63 x 48 x 30,5	1	113,15

**Can Suyu Musluğu**
**6071**

Ürün Kod	Cinsi	Ambalaj	Fiyat
CNS01	Can Suyu Musluğu	1	34,97

**12" Standart Dikdörtgen Vana Kutusu**
**6070**

Ürün Kod	Ebat	Ambalaj	Fiyat
VNK03	50,5 x 37 x 30,5	1	62,64

**Can Suyu Anahtarı**
**6071**

Ürün Kod	Cinsi	Ambalaj	Fiyat
CNS02	Can Suyu Anahtarı	1	9,40

**12" Standart Dikdörtgen Vana Kutusu Kilitli**
**6070**

Ürün Kod	Ebat	Ambalaj	Fiyat
VNK13	26,8 x 39,4 x 38	1	84,87

**Kaplin Küresel Vana**
**6072**

Ürün Kod	Ebat	Ambalaj	Fiyat
KVN03	1" Kaplin Küresel Vana	1	64,48
KVN04	1 1/4" Kaplin Küresel Vana	1	107,60
KVN05	1 1/2" Kaplin Küresel Vana	1	130,01



KVN16	2" Kaplin Küresel Vana (Metal Dişli)	1	289,90
-------	--------------------------------------	---	--------

**10" Junior Yuvarlak Vana Kutusu**
**6070**

Ürün Kod	Ebat	Ambalaj	Fiyat
VNK02	33,5 x 24 x 25,5	1	36,37

**Yuvarlak Damla Sulama Borusu (2-4 L/H)**
**3300**

Ürün Kod	Ölçü	Ambalaj	Fiyat/m
DML16	Düz Damlama Borusu	400	0,70
DML20	16x20 Delikli Yuvarlak	400	0,74
DML25	16x25 Delikli Yuvarlak	400	0,74
DML33	16x33 Delikli Yuvarlak	400	0,74
DML40	16x40 Delikli Yuvarlak	400	0,74
DML50	16x50 Delikli Yuvarlak	400	0,74

**6" Baby Yuvarlak Vana Kutusu**
**6070**

Ürün Kod	Ebat	Ambalaj	Fiyat
VNK01	20 x 16 x 24	1	18,98

**3/4 Vanalı Kutu**
**6070**

Ürün Kod	Ebat	Ambalaj	Fiyat
VNK05	18 x 18 x 12	1	99,98





**Modüler Kanal 130 Yeni**
**4015**

Ürün Kod	Ölçü	Ambalaj	Fiyat
MDK07	130 x 50 x 500 mm	Üretimde	
MDK08	130 x 120 x 500 mm	Üretimde	
MDK09	130 x 150 x 500 mm	Üretimde	

**Modüler Kanal 130 Köşe Yeni**
**4015**

Ürün Kod	Ölçü	Ambalaj	Fiyat
MDK27	130 x 50 x 130 mm	Üretimde	
MDK28	130 x 120 x 130 mm	Üretimde	

**Modüler Kanal 130 Kilitli Izgara**
**4014**

Ürün Kod	Ölçü	Ambalaj	Fiyat
MDK42	130/500 Modüler Kanal Kilitli Izgara	20	8,22

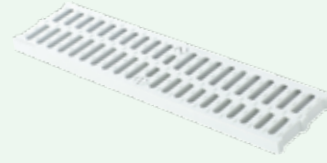
**Modüler Kanal 130 Tapa Yeni**
**4015**

Ürün Kod	Ölçü	Ambalaj	Fiyat
MDK29	Düz Tapa 130/50	Üretimde	
MDK30	Ø32 Yuvarlak Çıkışlı 130/50 Tapa	Üretimde	
MDK31	Düz Tapa 130/120	Üretimde	
MDK32	Ø75 Yuvarlak Çıkışlı 130/120 Tapa	Üretimde	

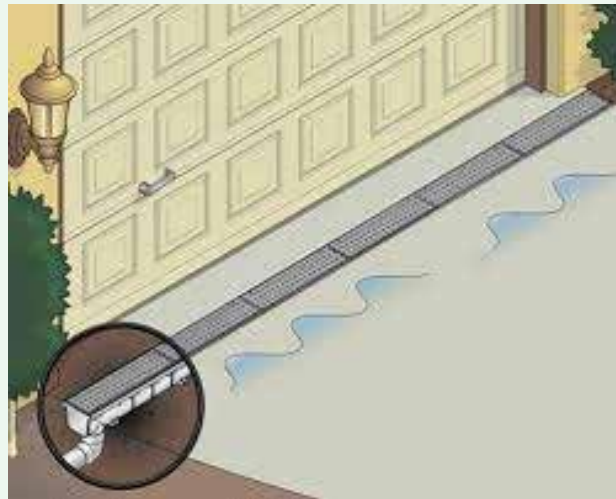



## MODÜLER KANAL

- Dayanıklılığı özel arttırılmış plastik hammadde
- Ekonomik ve Estetik
- **Hafif, kolay taşınabilir, pratik montaj**
- Darbelere karşı yüksek dirençli
- **Kimyasallara karşı dirençli**
- Kolay su akışı



### Modüler Kanal 130

**4013**

Ürün Kod	Ölçü	Ambalaj	Fiyat
MDK01	130x80x500 mm	20	9,35



### Modüler Kanal 130 Kilitli Izgara

**4013**

Ürün Kod	Ölçü	Ambalaj	Fiyat
MDK02	130/500 Plastik Izgara	20	7,42
MDK25	130/500 Paslanmaz Izgara	10	69,77
MDK35	130/500 Döküm Izgara	1	66,67

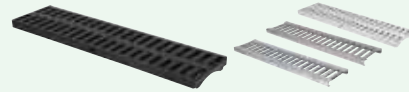

### Modüler Kanal 130

**4014**

Ürün Kod	Ölçü	Ambalaj	Fiyat
MDK40	130/80/1000 Modüler Kanal Oluk	10	18,68
MDK41	130/80/1000 Modüler Kanal Ø110 Alt Çıkış	16	19,25
MDK42	130/500 Modüler Kanal Kilitli Izgara	20	9,43

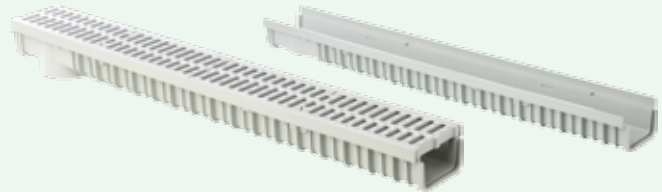

### Modüler Kanal 130 Köşe

**4013**

Ürün Kod	Ölçü	Ambalaj	Fiyat
MDK03	130 x 80	1	7,89



### Modüler Kanal 130 Tapa

**4013**

Ürün Kod	Ölçü	Ambalaj	Fiyat
MDK04	Düz Tapa 130/80	50	2,40
MDK05	ø50 Yuvarlak Çıkışlı 130/80 Tapa	50	2,80



### Modüler Kanal 130 Alttan Çıkış

**4013**

Ürün Kod	Ölçü	Ambalaj	Fiyat
MDK06	ø 110 ve 75 mm	30	3,30



# Yeni Dizayn Modüler Kanal - Kilitli Izgara



## Modüler Kanal 200

**4020**

Ürün Kod	Ürün Adı	Ambalaj	Fiyat
MDK11	Modüler Kanal 200/120/500	12	16,13
MDK12	Modüler Kanal 200/120/500 Alt Çıkış Ø75-Ø110	10	18,31
MDK13	Modüler Kanal 200/500 Kilitli Izgara	12	19,33
MDK14	Modüler Kanal 200/500 Tapa ø75	50	3,42
MDK26	Modüler Kanal 200/500 Paslanmaz Izgara	1	125,00
MDK36	Modüler Kanal 200/500 Döküm Izgara	1	92,31



## Modüler Kanal 100

**4010**

Ürün Kod	Ürün Adı	Ambalaj	Fiyat
MDK50	Modüler Kanal Takım 100	24	12,22
MDK16	Modüler Kanal 100/55/500	35	8,21
MDK17	Modüler Kanal 100/55/500 Alt Çıkış Ø75	30	7,98
MDK18	Modüler Kanal 100/500 Kilitli Izgara	38	6,95
MDK19	Modüler Kanal 100/500 Tapa ø32	50	2,40
MDK20	Modüler Kanal 100/500 Düz Tapa	50	2,40
MDK24	Modüler Kanal 100/500 Paslanmaz Izgara	1	46,51

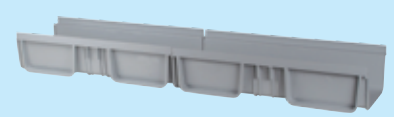
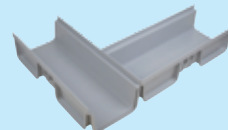
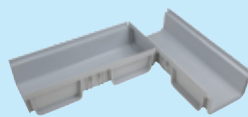

# Rögar Kapak ve Çerçevesi

## Çerçeve

**4240**



Ürün Kod	Ölçü	Ambalaj	Fiyat
RGCO1	22x22	20	<b>7,89</b>
RGCO2 *	30x30	10	<b>7,90</b>
RGCO3	32x32	10	<b>15,78</b>
RGCO4 *	40x40	5	<b>15,83</b>
RGCO6	42x42	5	<b>26,32</b>
RGCO8 *	50x50	5	<b>26,33</b>
RGCO9 *	60x60	2	<b>27,82</b>

## Çerçevesiz kapak

**4251**

Ürün Kod	Ölçü	Ambalaj	Fiyat
RCK01	22x22	20	<b>20,68</b>
RCK02 *	30x30	10	<b>20,69</b>
RCK03	32x32	10	<b>40,73</b>
RCK04 *	40x40	5	<b>40,83</b>
RCK06	42x42	5	<b>64,29</b>
RCK08 *	50x50	5	<b>69,61</b>
RCK09 *	60x60	4	<b>109,67</b>

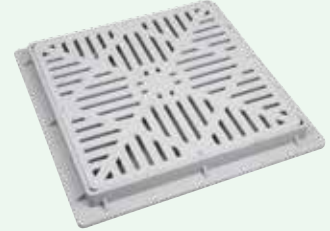
## Çerçevesiz Izgaralı Kapak

**4261**

Ürün Kod	Ölçü	Ambalaj	Fiyat
RCK21	22x22	20	<b>21,96</b>
RCK22 *	30x30	10	<b>21,97</b>
RCK23	32x32	10	<b>43,23</b>
RCK24 *	40x40	5	<b>43,33</b>
RCK26	42x42	5	<b>76,32</b>
RCK28 *	50x50	5	<b>73,94</b>
RCK29 *	60x60	2	<b>117,85</b>

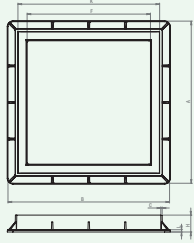

### Çerçeve Ölçüsü (mm)

	A	B	K	L	H
20x20	221.00	221.00	190.00	17.30	2.80
25x25	291.00	291.00	253.00	29.50	4.00
30x30	327.00	327.00	284.00	25.00	2.80
35x35	393.00	393.00	335.00	38.00	12.00
40x40	424.00	424.00	382.00	35.20	3.00
50x50	496.50	496.50	439.80	39.52	9.99
55x55	597.00	597.00	530.00	42.00	6.00

## Izgaralı Gri Kapak

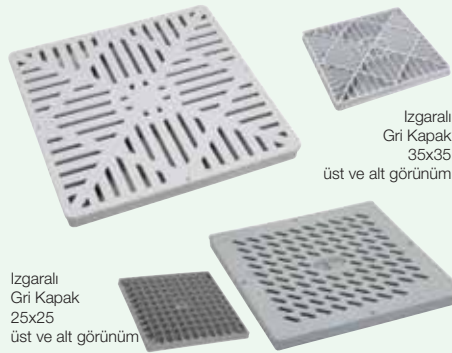
**4231**

 Izgaralı Gri Kapak  
35x35  
üst ve alt görünüm

 Izgaralı Gri Kapak  
25x25  
üst ve alt görünüm

Ürün Kod	Ölçü	Ambalaj	Fiyat
RGK21	20x20	20	<b>14,06</b>
RGK22 *	25x25	10	<b>14,07</b>
RGK23	30x30	10	<b>27,45</b>
RGK24 *	35x35	5	<b>27,51</b>
RGK25	36x26	1	<b>65,25</b>
RGK26	40x40	5	<b>50,00</b>
RGK28 *	50x50	5	<b>47,60</b>
RGK29 *	55x55	4	<b>90,03</b>

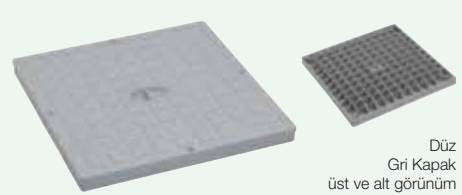
## Düz Gri Kapak

**4221**

 Düz Gri Kapak  
üst ve alt görünüm

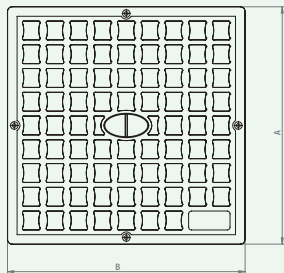
Ürün Kod	Ölçü	Ambalaj	Fiyat
RGK01	20x20	20	<b>12,78</b>
RGK02 *	25x25	10	<b>12,79</b>
RGK03	30x30	10	<b>24,96</b>
RGK04 *	35x35	5	<b>25,01</b>
RGK05	36x26	1	<b>47,18</b>
RGK06	40x40	5	<b>37,97</b>
RGK07	48x48	1	<b>60,00</b>
RGK08 *	50x50	5	<b>43,28</b>
RGK09 *	55x55	4	<b>81,85</b>



### Kapak Ölçüsü (mm)

	A	B	L	H
20x20	189.00	189.00	21.00	18.00
25x25	252.00	252.00	27.00	19.00
30x30	282.40	282.40	32.00	20.05
35x35	333.00	333.00	34.00	27.50
40x40	382.00	382.00	37.00	23.00
50x50	440.00	440.00	39.00	29.50
55x55	529.00	529.00	57.00	36.00

## Düz Yeşil Kapak

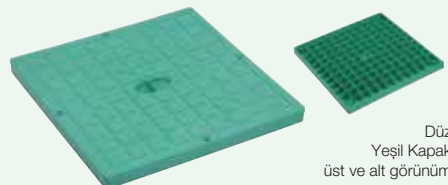
**4222**

 Düz Yeşil Kapak  
üst ve alt görünüm

Ürün Kod	Ölçü	Ambalaj	Fiyat
RGK11	20x20	20	<b>14,06</b>
RGK12 *	25x25	10	<b>14,07</b>
RGK13	30x30	10	<b>27,45</b>
RGK14 *	35x35	5	<b>27,51</b>
RGK16	40x40	5	<b>50,00</b>
RGK18 *	50x50	5	<b>47,60</b>
RGK19 *	55x55	2	<b>90,03</b>

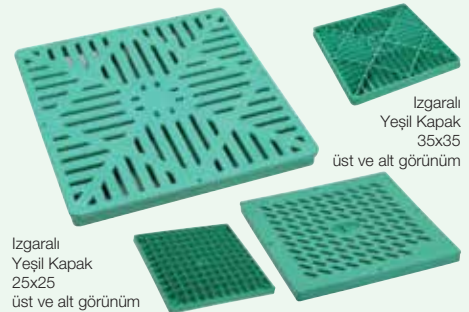
## Izgaralı Yeşil Kapak

**4232**

 Izgaralı Yeşil Kapak  
35x35  
üst ve alt görünüm

 Izgaralı Yeşil Kapak  
25x25  
üst ve alt görünüm

Ürün Kod	Ölçü	Ambalaj	Fiyat
RGK31	20x20	20	<b>14,06</b>
RGK32 *	25x25	10	<b>14,07</b>
RGK33	30x30	10	<b>27,45</b>
RGK34 *	35x35	5	<b>27,51</b>
RGK36	40x40	5	<b>50,00</b>
RGK38 *	50x50	5	<b>47,60</b>
RGK39 *	55x55	4	<b>90,03</b>

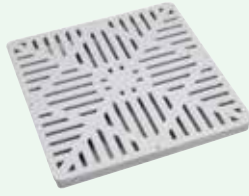
## Yeni Nesil Röggar Kutuları



- Nakliye esnasında ezilme ve kırılmaya son.
- Güçlendirilmiş yeni kapak ve kutu tasarımı ile daha fazla yük taşıyabilir.
- Dekoratif yeni kapak modelleri

**4100**

Kod	Ürün Adı	Ölçü	Ambalaj	Fiyat
RGA25	Röggar Kapaklı Kutu	25x25	1	19,36
RGA26	Röggar Kapaksız Kutu	25x25	1	11,00
RGA35	Röggar Kapaklı Kutu	35x35	1	45,37
RGA36	Röggar Kapaksız Kutu	35x35	1	26,95

**4221**

Kod	Ürün Adı	Ölçü	Ambalaj	Fiyat
RGK02	Röggar Düz Gri Kapak	25x25	1	12,79
RGK04	Röggar Düz Gri Kapak	35x35	1	25,01

**4231**

Kod	Ürün Adı	Ölçü	Ambalaj	Fiyat
RGK22	Röggar Izgaralı Gri Kapak	25x25	1	14,07
RGK24	Röggar Izgaralı Gri Kapak	35x35	1	27,51

**4110**

Kod	Ürün Adı	Ölçü	Ambalaj	Fiyat
RGA01	Röggar Kutu Adaptörü	50 - 75 - 110	1	6,20
RGA02	Röggar Kutu Adaptörü	125	1	6,20



Bahçe Süzgeçlerine Uyumlu

İç İçe Geçebilme Özelliğiyle Stok ve Nakliyede %50 Tasarruf

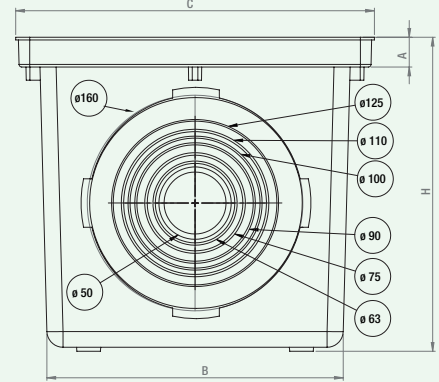

## Montaj Seçenekleri

### 1- Direk Boru Montajına Uygunluk

Suyun doğal akışını sağlamak için kutuya eğimli boru takılabilir.



### 2- Adaptörlü Montaj

- Adaptör kullanımı sayesinde su sızdırmazlığın kesin önleyicisidir.
- Eğimli Boru montajı imkanı vardır.
- Adaptör ile röggar kutusuna muflu boru takılabilir.



# Lineer Duş Kanalları

- 304 Paslanmaz Çelik ızgara
- En düşük beton şap payı  
(MidLine 77mm, HighLine 81mm)
- 16 cm<sup>2</sup> su tahliye deliği
- Koku önleyici sistemli
- Yükseklik ayarlı ayaklar
- Bakteri kümelenmelerine karşı pürüzsüz iç yüzey
- Yeni iç dizaynı sayesinde hızlı ve kolay su tahliyesi
- Özel dizaynı sayesinde suyun akışıyla kendi kendini temizleme özelliği

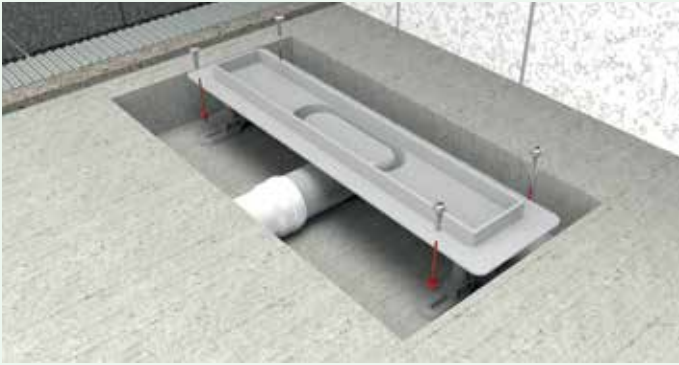

## Lineer Duş Kanalları MidLine Serisi

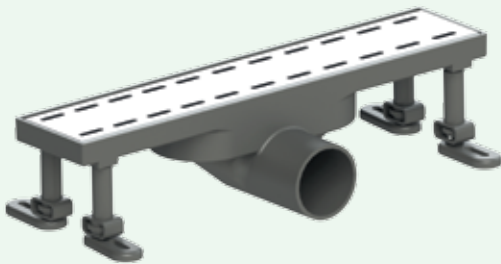
**4800**

Ürün Kod	Ölçü	Ambalaj	Fiyat
LDM33	ML Lineer Duş Kanalı Ø50 Yan Çıkış 33 cm	20	58,58

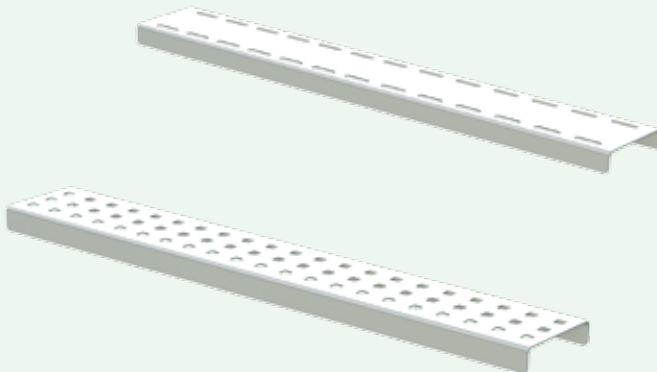

## Lineer Duş Kanalları HighLine Serisi

**4850**

Ürün Kod	Ölçü	Ambalaj	Fiyat
LDH40	HL Lineer Duş Kanalı Ø50 Yan Çıkış 40 cm	10	67,14
LDH50	HL Lineer Duş Kanalı Ø50 Yan Çıkış 50 cm	23	78,07
LDH60	HL Lineer Duş Kanalı Ø50 Yan Çıkış 60 cm	20	90,86
LDH80	HL Lineer Duş Kanalı Ø50 Yan Çıkış 80 cm	20	115,65



## Lineer Duş Kanalları HighLine Serisi

**4855**

Ürün Kod	Ölçü	Ambalaj	Fiyat
LDA20	HL Lineer Duş Kanalı Ø50 Alt Çıkış 20 cm	25	44,91
LDA33	HL Lineer Duş Kanalı Ø50 Alt Çıkış 33 cm	17	57,70
LDA40	HL Lineer Duş Kanalı Ø50 Alt Çıkış 40 cm	10	64,58
LDA50	HL Lineer Duş Kanalı Ø50 Alt Çıkış 50 cm	23	77,37
LDA60	HL Lineer Duş Kanalı Ø50 Alt Çıkış 60 cm	20	89,26
LDA80	HL Lineer Duş Kanalı Ø50 Alt Çıkış 80 cm	20	113,44

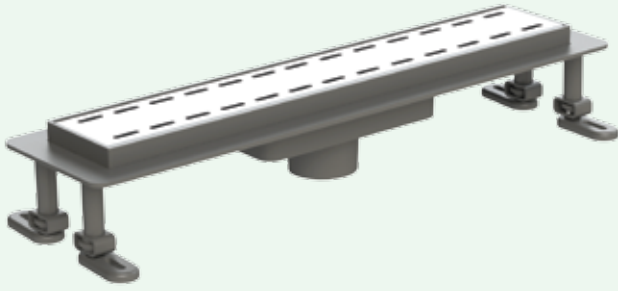

## Tekstil Membranlı Lineer Duş Kanalı

**4859**

Ürün Kod	Ölçü	Ambalaj	Fiyat
LTA20	HL Lineer Duş Kanalı Teks. Memb. Ø50 Alt Çıkış 20 cm	1	51,72
LTA33	HL Lineer Duş Kanalı Teks. Memb. Ø50 Alt Çıkış 33 cm	1	64,42
LTA40	HL Lineer Duş Kanalı Teks. Memb. Ø50 Alt Çıkış 40 cm	1	73,02
LTA50	HL Lineer Duş Kanalı Teks. Memb. Ø50 Alt Çıkış 50 cm	1	84,74
LTA60	HL Lineer Duş Kanalı Teks. Memb. Ø50 Alt Çıkış 60 cm	1	96,88
LTA80	HL Lineer Duş Kanalı Teks. Memb. Ø50 Alt Çıkış 80 cm	1	121,79

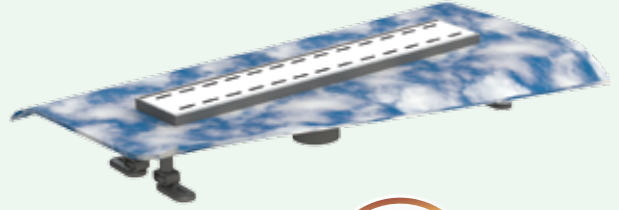

## Lineer Klapeli Duş Kanalları

**Patentli  
ürün**
**YENİ**
**4852**

Ürün Kod	Ölçü	Ambalaj	Fiyat
LKD12	Lineer Klapeli Duş Kanalı Ø32 Yan Çıkış 20 cm	1	34,14
LKD13	Lineer Klapeli Duş Kanalı Ø32 Yan Çıkış 33 cm	1	45,47
LKD14	Lineer Klapeli Duş Kanalı Ø32 Yan Çıkış 40 cm	1	50,19
LKD32	Lineer Klapeli Duş Kanalı Ø50 Yan Çıkış 20 cm	1	39,07
LKD33	Lineer Klapeli Duş Kanalı Ø50 Yan Çıkış 33 cm	1	52,09
LKD34	Lineer Klapeli Duş Kanalı Ø50 Yan Çıkış 40 cm	1	57,44

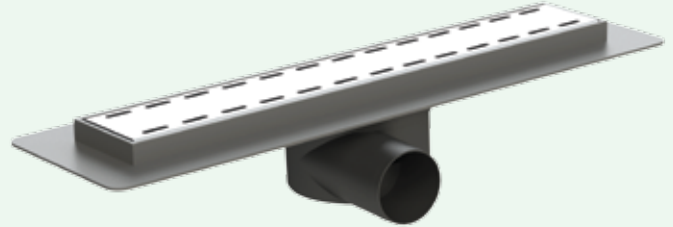

## Lineer Klapeli ve Fileli Duş Kanalları

**YENİ**
**4853**

Ürün Kod	Ölçü	Ambalaj	Fiyat
LFD12	Lineer Klapeli ve Fileli Ø32 Yan Çıkış 20 cm	1	40,98
LFD13	Lineer Klapeli ve Fileli Ø32 Yan Çıkış 33 cm	1	52,63
LFD14	Lineer Klapeli ve Fileli Ø32 Yan Çıkış 40 cm	1	57,70
LFD32	Lineer Klapeli ve Fileli Ø50 Yan Çıkış 20 cm	1	46,05
LFD33	Lineer Klapeli ve Fileli Ø50 Yan Çıkış 33 cm	1	59,07
LFD34	Lineer Klapeli ve Fileli Ø50 Yan Çıkış 40 cm	1	64,88

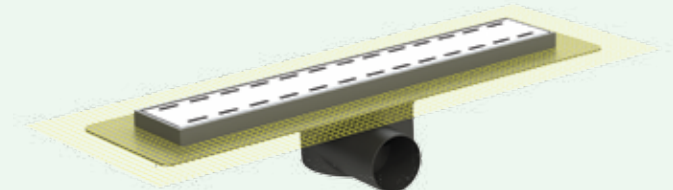

## Tekstil Membranlı Lineer Duş Kanalları

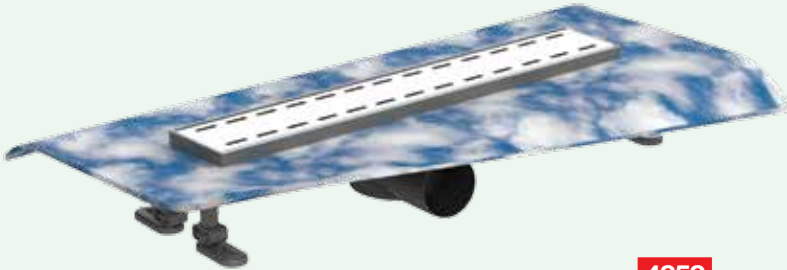
**4858**

Ürün Kod	Ölçü	Ambalaj	Fiyat
LTM40	HL Lineer Duş Kanalı Teks. Memb. Ø50 Yan Çıkış 40 cm	1	73,02
LTM50	HL Lineer Duş Kanalı Teks. Memb. Ø50 Yan Çıkış 50 cm	1	85,44
LTM60	HL Lineer Duş Kanalı Teks. Memb. Ø50 Yan Çıkış 60 cm	1	98,49
LTM80	HL Lineer Duş Kanalı Teks. Memb. Ø50 Yan Çıkış 80 cm	1	123,79



# Geniş Su Gideri & Su Depolama Hazneli, Koku Gidericili ve Patentli Yeni Dizayn Süzgeçler

**Plastik Yer Süzgeci**
**4401**

Kod	Ürün Adı	Ambalaj	Fiyat
PSY01	10 x 10 Yan Çıkış Ø32	100	3,39
PSY03	10 x 10 Yan Çıkış Ø50	70	3,39

**Plastik Yer Süzgeci**
**4411**

Kod	Ürün Adı	Ambalaj	Fiyat
PAS13	10 x 10 Alt Çıkış Ø50	100	3,39
PAS14	10 x 10 Alt Çıkış Ø75	75	3,39

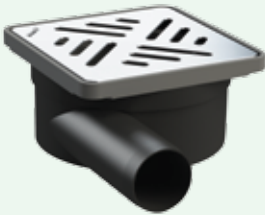

**Paslanmaz Izgaralı Plastik Yer Süzgeci nano™**
**4421**

Kod	Ürün Adı	Ambalaj	Fiyat
PPS01	10 x 10 Yan Çıkış Ø32	100	7,79
PPS03	10 x 10 Yan Çıkış Ø50	70	7,79
PPS21	15 x 15 Yan Çıkış Ø32	48	15,79
PPS23	15 x 15 Yan Çıkış Ø50	36	15,79
PPS24	15 x 15 Yan Çıkış Ø75	24	16,92

- Sulu sistem koku önleyici dizayn.
- Paslanmaz ve kararmaz 304 çelik izgaralı süzgeç.

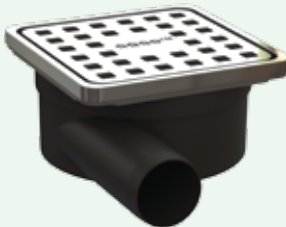

**Paslanmaz Izgaralı Plastik Yer Süzgeci nano™**
**4422**

Kod	Ürün Adı	Ambalaj	Fiyat
PPS13	10 x 10 Alt Çıkış Ø50	90	7,79
PPS14	10 x 10 Alt Çıkış Ø75	75	7,79
PPS33	15 x 15 Alt Çıkış Ø50	30	14,90
PPS34	15 x 15 Alt Çıkış Ø75	28	15,47

**Paslanmaz Çerçeve ve Izgaralı Plastik Yer Süzgeci**
**4431**

Kod	Ürün Adı	Ambalaj	Fiyat
PCS01	10 x 10 Yan Çıkış Ø32	72	19,57
PCS03	10 x 10 Yan Çıkış Ø50	54	19,57
PCS21	15 x 15 Yan Çıkış Ø32	48	24,68
PCS23	15 x 15 Yan Çıkış Ø50	36	24,68
PCS24	15 x 15 Yan Çıkış Ø75	24	25,77

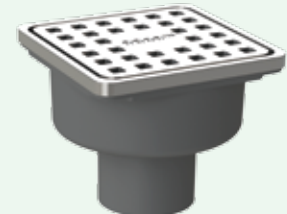
- Sulu sistem koku önleyici dizayn.
- Paslanmaz ve kararmaz 304 çelik izgaralı süzgeç.

**Paslanmaz Çerçeve ve Izgaralı Plastik Yer Süzgeci**
**4432**

Kod	Ürün Adı	Ambalaj	Fiyat
PCS13	10 x 10 Alt Çıkış Ø50	50	19,57
PCS14	10 x 10 Alt Çıkış Ø75	50	19,57
PCS33	15 x 15 Alt Çıkış Ø50	45	24,68
PCS34	15 x 15 Alt Çıkış Ø75	42	25,70

- Sulu sistem koku önleyici dizayn.
- Paslanmaz ve kararmaz 304 çelik izgaralı süzgeç.



# Geniş Su Gideri & Su Depolama Hazneli, Koku Gidericili, Klapeli ve Patentli Yeni Dizayn Süzgeçler



## Paslanmaz Izgaralı Klapeli Plastik Yer Süzgeci

 nano™ **4415**

Kod	Ürün Adı	Ambalaj	Fiyat
PKS01	10 x 10 Yan Çıkış Ø32 Klapeli	100	9,00
PKS03	10 x 10 Yan Çıkış Ø50 Klapeli	70	9,00
PKS21	15 x 15 Yan Çıkış Ø32 Klapeli	48	17,26
PKS23	15 x 15 Yan Çıkış Ø50 Klapeli	36	17,26
PKS24	15 x 15 Yan Çıkış Ø75 Klapeli	24	18,26

- Sulu ve klapeli sistem koku önleyici dizayn.
- Paslanmaz ve kararmaz 304 çelik izgaralı süzgeç.

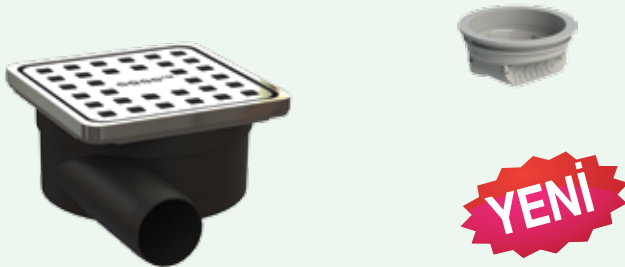

## Paslanmaz Çerçeve ve Izgaralı Klapeli Plastik Yer Süzgeci

 nano™ **4425**

Kod	Ürün Adı	Ambalaj	Fiyat
*PCK01	10 x 10 Yan Çıkış Ø32 Klapeli	100	20,59
*PCK03	10 x 10 Yan Çıkış Ø50 Klapeli	70	20,59
PCK21	15 x 15 Yan Çıkış Ø32 Klapeli	48	26,10
PCK23	15 x 15 Yan Çıkış Ø50 Klapeli	36	26,10
PCK24	15 x 15 Yan Çıkış Ø75 Klapeli	24	27,10

- Sulu ve klapeli sistem koku önleyici dizayn.
- Paslanmaz ve kararmaz 304 çelik izgaralı süzgeç.
- \* Üretim Aşamasında



## Paslanmaz Izgaralı Klapeli Plastik Yer Süzgeci

 nano™ **4423**

Kod	Ürün Adı	Ambalaj	Fiyat
PKS13	10 x 10 Alt Çıkış Ø50 Klapeli	100	9,00
PKS14	10 x 10 Alt Çıkış Ø75 Klapeli	75	9,00
PKS33	15 x 15 Alt Çıkış Ø50 Klapeli	45	16,26
PKS34	15 x 15 Alt Çıkış Ø75 Klapeli	42	16,49

- Sulu ve klapeli sistem koku önleyici dizayn.
- Paslanmaz ve kararmaz 304 çelik izgaralı süzgeç.

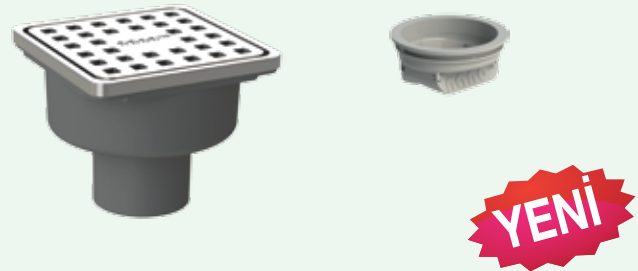

## Paslanmaz Çerçeve ve Izgaralı Klapeli Plastik Yer Süzgeci

 nano™ **4426**

Kod	Ürün Adı	Ambalaj	Fiyat
PCK13	10 x 10 Alt Çıkış Ø50 Klapeli	75	20,59
PCK14	10 x 10 Alt Çıkış Ø75 Klapeli	75	20,59
PCK33	15 x 15 Alt Çıkış Ø50 Klapeli	30	25,10
PCK34	15 x 15 Alt Çıkış Ø75 Klapeli	36	25,51

- Sulu ve klapeli sistem koku önleyici dizayn.
- Paslanmaz ve kararmaz 304 çelik izgaralı süzgeç.



## Plastik Yer Süzgeci

**4405**

Kod	Ürün Adı	Ambalaj	Fiyat
PSY23	15 x 15 Yan Çıkış Ø50	36	7,31

# Pis Su Boru Uyumlu İzolasyon Etekli Yükseklik Ayarlı Süzgeç

## Süzgeç Ek Parçaları

**4500**

Kod	Ürün Adı	Ambalaj	Fiyat
YAS30	Yan Çıkış Ø50 Yalıtım Etekli Süzgeç Altı	20	6,10
YAS40	Alt Çıkış Ø110 Yalıtım Etekli Süzgeç Altı	20	3,90
YAS41	Alt Çıkış Ø110 Yalıtım Eteksiz Süzgeç Altı	20	3,90
YAS42	Alt Çıkış Ø75 Yalıtım Etekli Süzgeç Altı	20	3,90
YAS43	Alt Çıkış Ø75 Yalıtım Eteksiz Süzgeç Altı	20	3,90
YAS44	Alt Çıkış Ø50 Yalıtım Etekli Süzgeç Altı	20	3,90
YAS45	Alt Çıkış Ø50 Yalıtım Eteksiz Süzgeç Altı	20	3,90
YAS50	10 x 10 Yalıtım Etekli Süzgeç Üst Gövdesi	20	3,42
YAS51	10 x 10 Yalıtım Etekli Süzgeç Üst Kısa Gövdesi	20	3,42
YAS55	15 x 15 Yalıtım Etekli Süzgeç Üst Gövdesi	20	3,68
YAS56	15 x 15 Yalıtım Etekli Süzgeç Üst Kısa Gövdesi	20	3,68
YAS60	Klape ve su hazneli Koku Gidericili Süzgeç Tası	20	4,87
YAS68	10 x 10 Plastik Izgara	20	1,06
YAS70	10 x 10 Paslanmaz Izgara	20	5,81
YAS71	10 x 10 Paslanmaz Kare Izgara	20	5,81
YAS75	15 x 15 Paslanmaz Izgara	20	12,21
YAS76	15 x 15 Paslanmaz Kare Izgara	20	12,21
YAS80	10 x 10 Paslanmaz Çerçeve ve Izgara	20	17,95
YAS85	15 x 15 Paslanmaz Çerçeve ve Izgara	20	17,95
YAS90	Paslanmaz Flanş	20	15,12
YAK61	Yan Çıkış Ø32 İzolasyon Etekli Kendinden Koku Gidericili Süzgeç Altı	20	6,10
YAK62	Yan Çıkış Ø60 İzolasyon Etekli Kendinden Koku Gidericili Süzgeç Altı	20	6,10
YAK63	Yan Çıkış Ø75 İzolasyon Etekli Kendinden Koku Gidericili Süzgeç Altı	20	6,10

**4501**

Kod	Ürün Adı	Amb.	Fiyat
SZK01	Ø60 Süzgeç Klape Kapak	20	1,03
SZK02	Ø75 Süzgeç Klape Kapak	20	1,03
SZK03	Ø90 Süzgeç Klape Kapak	20	1,47

**4502**

Kod	Ürün Adı	Amb.	Fiyat
SZC01	Süzgeç Conta	1	5,26
SZC02	Süzgeç Flanş Vidası	1	0,85
MBR10	Süzgeç Membran	20	8,33
TMR11	Süzgeç Tekstil Membran	20	8,33
FLE15	Süzgeç Filesi	20	6,05

 YAK62  
Ø60 Yan Çıkışlı İzolasyon Etekli Koku Gidericili Süzgeç Altı

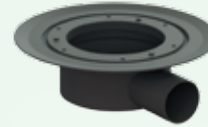
 YAS30  
Ø50 Yan Çıkışlı Yalıtım Etekli Süzgeç Altı

 YAS40  
Ø110 Alt Çıkışlı Yalıtım Etekli Süzgeç Altı

 YAS41  
Ø110 Alt Çıkışlı Yalıtım Eteksiz Süzgeç Altı

 YAS42  
Ø75 Alt Çıkışlı Yalıtım Etekli Süzgeç Altı

 YAS43  
Ø75 Alt Çıkışlı Yalıtım Eteksiz Süzgeç Altı

 YAS44  
Ø60 Alt Çıkışlı Yalıtım Etekli Süzgeç Altı

 YAS45  
Ø50 Alt Çıkışlı Yalıtım Eteksiz Süzgeç Altı

 YAS50  
Yalıtım Etekli Süzgeç Üst Gövdesi 10x10

 YAS51  
Yalıtım Etekli Süzgeç Üst Kısa Gövdesi 10x10

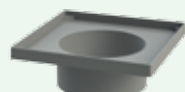
 YAS55  
Yalıtım Etekli Süzgeç Üst Gövdesi 15x15

 YAS56  
Yalıtım Etekli Süzgeç Üst Kısa Gövdesi 15x15

 SZK01  
Ø60 Süzgeç Klape Kapak

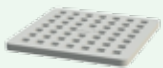
 SZK02  
Ø75 Süzgeç Klape Kapak

 SZK03  
Ø90 Süzgeç Klape Kapak

 YAS68  
10x10 Plastik Izgara

 YAS71  
10x10 Paslanmaz Kare Izgara

 YAS70  
10x10 Paslanmaz Izgara

 YAS80  
Paslanmaz Çerçeve ve Izgara 10 x 10

 YAS85  
Paslanmaz Çerçeve ve Izgara 15 x 15

 YAS75  
Paslanmaz Izgara 15x15

 YAS60  
Klape ve Su Hazneli Koku Gidericili Süzgeç Tası

 YAS90  
Yalıtım Etekli Süzgeç Paslanmaz Flanş

 SZC01  
Conta

 MBR10  
Membran

# Pis Su Boru Uyumlu ve Kendinden Koku Gidericili İzolasyon Etekli Süzgeç Altı

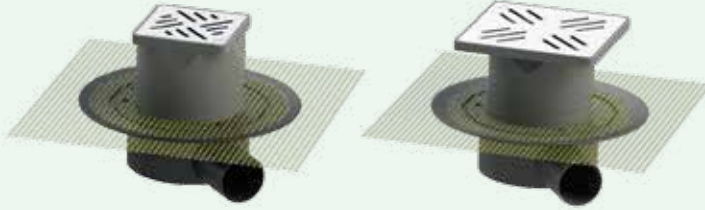
**4551**

Kod	Ürün Adı	Amb.	Fiyat
YAF30	Yan Çıkış Ø50 Yalıtım Etekli Fileli Süzgeç Altı	20	12,14
YAF40	Alt Çıkış Ø110 Yalıtım Etekli Fileli Süzgeç Altı	20	9,95
YAF42	Alt Çıkış Ø75 Yalıtım Etekli Fileli Süzgeç Altı	20	9,95
YAF44	Alt Çıkış Ø50 Yalıtım Etekli Fileli Süzgeç Altı	20	9,95
YKF61	Yan Çıkış Ø32 Fileli İzolasyon Etekli Kendinden Koku Gidericili Süzgeç Altı	20	12,14
YKF62	Yan Çıkış Ø50 Fileli İzolasyon Etekli Kendinden Koku Gidericili Süzgeç Altı	20	12,14
YKF63	Yan Çıkış Ø75 Fileli İzolasyon Etekli Kendinden Koku Gidericili Süzgeç Altı	20	12,14

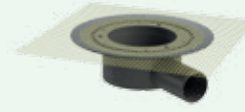

YAF30  
Ø50 Yan Çıkışlı Yalıtım Etekli  
Fileli Süzgeç Altı



YAF40  
Ø110 Alt Çıkışlı Yalıtım Etekli  
Fileli Süzgeç Altı

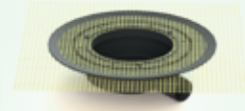

YKF61  
Ø32 Yan Çıkışlı File İzolasyon Etekli  
Koku Gidericili Süzgeç Altı



YAF42  
Ø75 Alt Çıkışlı Yalıtım Etekli  
Fileli Süzgeç Altı



YKF62  
Ø50 Yan Çıkışlı File İzolasyon Etekli  
Koku Gidericili Süzgeç Altı



YAF44  
Ø50 Alt Çıkışlı Yalıtım Etekli  
Fileli Süzgeç Altı



YKF63  
Ø75 Yan Çıkışlı File İzolasyon Etekli  
Koku Gidericili Süzgeç Altı



YAM30  
Ø50 Yan Çıkışlı İzolasyon Etekli  
Membranlı Süzgeç Altı

Kod	Ürün Adı	Amb.	Fiyat
YAM30	Yan Çıkış Ø50 Yalıtım Etekli Membranlı Süzgeç Altı	20	35,66
YAM40	Alt Çıkış Ø110 Yalıtım Etekli Membranlı Süzgeç Altı	20	33,47
YAM42	Alt Çıkış Ø75 Yalıtım Etekli Membranlı Süzgeç Altı	20	33,47
YAM44	Alt Çıkış Ø50 Yalıtım Etekli Membranlı Süzgeç Altı	20	33,47
YKM61	Yan Çıkış Ø32 İzolasyon Etekli Kendinden Koku Gidericili Membranlı Süzgeç Altı	20	35,66
YKM62	Yan Çıkış Ø50 İzolasyon Etekli Kendinden Koku Gidericili Membranlı Süzgeç Altı	20	35,66
YKM63	Yan Çıkış Ø75 İzolasyon Etekli Kendinden Koku Gidericili Membranlı Süzgeç Altı	20	35,66

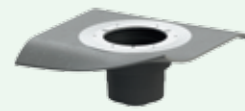
**4561**

YAM40  
Ø110 Alt Çıkışlı Yalıtım Etekli  
Membranlı Süzgeç Altı



YKM61  
Ø32 Yan Çıkışlı İzolasyon Etekli  
Kendinden Koku Gidericili Membranlı Süzgeç Altı

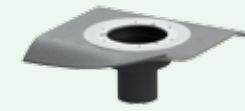

YAM42  
Ø75 Alt Çıkışlı Yalıtım Etekli  
Membranlı Süzgeç Altı



YKM62  
Ø50 Yan Çıkışlı İzolasyon Etekli  
Kendinden Koku Gidericili Membranlı Süzgeç Altı

Kod	Ürün Adı	Amb.	Fiyat
YAT30	Yan Çıkış Ø50 Yalıtım Etekli Tekstil Membranlı Süzgeç Altı	20	35,66
YAT40	Alt Çıkış Ø110 Yalıtım Etekli Tekstil Membranlı Süzgeç Altı	20	33,47
YAT42	Alt Çıkış Ø75 Yalıtım Etekli Tekstil Membranlı Süzgeç Altı	20	33,47
YAT44	Alt Çıkış Ø50 Yalıtım Etekli Tekstil Membranlı Süzgeç Altı	20	33,47
YKT61	Yan Çıkış Ø32 İzolasyon Etekli Kendinden Koku Gidericili Tekstil Memb. Süzgeç Altı	20	35,66
YKT62	Yan Çıkış Ø50 İzolasyon Etekli Kendinden Koku Gidericili Tekstil Memb. Süzgeç Altı	20	35,66
YKT63	Yan Çıkış Ø75 İzolasyon Etekli Kendinden Koku Gidericili Tekstil Memb. Süzgeç Altı	20	35,66

**4571**

YAM44  
Ø50 Alt Çıkışlı Yalıtım Etekli  
Membranlı Süzgeç Altı



YKM63  
Ø75 Yan Çıkışlı İzolasyon Etekli  
Kendinden Koku Gidericili Membranlı Süzgeç Altı

# ÇİFT KOKU GİDERİCİLİ YÜKSEKLİK AYARLI SÜZGEÇ

- Klape ve su haznesi sayesinde çift koku giderici özelliği sahiptir.
- Su tahliye deliğinin geniş dizaynı sayesinde maksimum su tahliye imkanı vardır.
- Su tahliye yolu iki kanallıdır.
- Parça değiştirme kolaylığı ve temizlenebilme imkanı vardır.
- 110 mm pis su boru montajına da uyumludur.

110 mm pis su borunun conta mufuna ve 110 mm borunun iç kısmına yükseklik ayarlı süzgeci takabilme imkanı



YAS05 10x10 - Ø110



YAS06 15x15 - Ø110



YAS07 10x10 - Ø100



YAS08 15x15 - Ø100

## Klape ve Koku Gidericili Yükseklik Ayarlı Süzgeçler

**4510**

Kod	Ürün Adı	Ambalaj	Fiyat
YAS05	10 x10 -Ø110 Klape ve Koku Gidericili Yük. Ayarlı Süz. Takım	20	14,10
YAS06	15 x15 -Ø110 Klape ve Koku Gidericili Yük. Ayarlı Süz. Takım	20	20,76
YAS07	10 x10 -Ø100 Klape ve Koku Gidericili Yük. Ayarlı Kısa Süz. Takım	20	14,10
YAS08	15 x15 -Ø100 Klape ve Koku Gidericili Yük. Ayarlı Kısa Süz. Takım	20	20,76

## Klape ve Koku Gidericili Yalıtım Eteksiz Yükseklik Ayarlı Süzgeçler

**4512**

Kod	Ürün Adı	Ambalaj	Fiyat
YAS31	10 x 10 - Alt Çıkış Ø60 Yalıtım Eteksiz Süzgeç Takım	20	18,01
YAS32	15 x 15 - Alt Çıkış Ø60 Yalıtım Eteksiz Süzgeç Takım	20	24,66
YAS33	10 x 10 - Alt Çıkış Ø75 Yalıtım Eteksiz Süzgeç Takım	20	18,01
YAS34	15 x 15 - Alt Çıkış Ø75 Yalıtım Eteksiz Süzgeç Takım	20	24,66
YAS35	10 x 10 - Alt Çıkış Ø110 Yalıtım Eteksiz Süzgeç Takım	20	18,01
YAS36	15 x 15 - Alt Çıkış Ø110 Yalıtım Eteksiz Süzgeç Takım	20	24,66



YAS31 10x10 - Ø60 Alt Çıkışli



YAS33 10x10 - Ø75 Alt Çıkışli



YAS35 10x10 - Ø110 Alt Çıkışli



YAS32 15x15 - Ø60 Alt Çıkışli



YAS34 15x15 - Ø75 Alt Çıkışli



YAS36 15x15 - Ø110 Alt Çıkışli

## Klape ve Koku Gidericili Yalıtım Etekli Yükseklik Ayarlı Süzgeçler

**4511**

Kod	Ürün Adı	Ambalaj	Fiyat
YAS10	10 x 10 Yan Çıkış Ø50 Yalıtım Etekli Süzgeç Takım	20	41,43
YAS15	15 x 15 Yan Çıkış Ø50 Yalıtım Etekli Süzgeç Takım	20	48,09
YAS21	10 x 10 Alt Çıkış Ø50 Yalıtım Etekli Süzgeç Takım	20	39,24
YAS22	15 x 15 Alt Çıkış Ø50 Yalıtım Etekli Süzgeç Takım	20	45,89
YAS23	10 x 10 Alt Çıkış Ø75 Yalıtım Etekli Süzgeç Takım	20	39,24
YAS24	15 x 15 Alt Çıkış Ø75 Yalıtım Etekli Süzgeç Takım	20	45,89
YAS25	10 x 10 Alt Çıkış Ø110 Yalıtım Etekli Süzgeç Takım	20	39,24
YAS26	15 x 15 Alt Çıkış Ø110 Yalıtım Etekli Süzgeç Takım	20	45,89



YAS10 10x10 - Ø50 Yan Çıkışli



YAS15 15x15 - Ø50 Yan Çıkışli



YAS21 10x10 - Ø50 Alt Çıkışli



YAS23 10x10 - Ø75 Alt Çıkışli



YAS25 10x10 - Ø110 Alt Çıkışli



YAS22 15x15 - Ø50 Alt Çıkışli



YAS24 15x15 - Ø75 Alt Çıkışli



YAS26 15x15 - Ø110 Alt Çıkışli

Kod	Ürün Adı	Ambalaj	Fiyat
YAS61	10 x 10 Yan Çıkış Ø32 İz. Etekli Kendinden Koku Gidericili Süzgeç Tak.	20	38,03
YAS62	10 x 10 Yan Çıkış Ø50 İz. Etekli Kendinden Koku Gidericili Süzgeç Tak.	20	38,03
YAS63	10 x 10 Yan Çıkış Ø75 İz. Etekli Kendinden Koku Gidericili Süzgeç Tak.	20	38,03
YAS64	15 x 15 Yan Çıkış Ø32 İz. Etekli Kendinden Koku Gidericili Süzgeç Tak.	20	44,69
YAS65	15 x 15 Yan Çıkış Ø50 İz. Etekli Kendinden Koku Gidericili Süzgeç Tak.	20	44,69
YAS66	15 x 15 Yan Çıkış Ø75 İz. Etekli Kendinden Koku Gidericili Süzgeç Tak.	20	44,69

\* Paslanmaz flanş fiyata dahildir.

## Klape ve Koku Gidericili Fileli - Yalıtım Etekli Yükseklik Ayarlı Süzgeçler

**4521**

Kod	Ürün Adı	Amb.	Fiyat
YAF10	10 x 10 - Yan Çıkış Ø50 Fileli - Yalıtım Etekli Süzgeç Takım	20	26,25
YAF15	15 x 15 - Yan Çıkış Ø50 Fileli - Yalıtım Etekli Süzgeç Takım	20	32,90
YAF21	10 x 10 - Alt Çıkış Ø50 Fileli - Yalıtım Etekli Süzgeç Takım	20	24,05
YAF22	15 x 15 - Alt Çıkış Ø50 Fileli - Yalıtım Etekli Süzgeç Takım	20	30,71
YAF23	10 x 10 - Alt Çıkış Ø75 Fileli - Yalıtım Etekli Süzgeç Takım	20	24,05
YAF24	15 x 15 - Alt Çıkış Ø75 Fileli - Yalıtım Etekli Süzgeç Takım	20	30,71
YAF25	10 x 10 - Alt Çıkış Ø110 Fileli - Yalıtım Etekli Süzgeç Takım	20	24,05
YAF26	15 x 15 - Alt Çıkış Ø110 Fileli - Yalıtım Etekli Süzgeç Takım	20	30,71

Kod	Ürün Adı	Amb.	Fiyat
YAF61	10 x 10 Yan Çıkış Ø32 İzolasyon Etekli Kendinden Koku Gidericili Fileli Süzgeç Takım	20	22,85
YAF62	10 x 10 Yan Çıkış Ø50 İzolasyon Etekli Kendinden Koku Gidericili Fileli Süzgeç Takım	20	22,85
YAF63	10 x 10 Yan Çıkış Ø75 İzolasyon Etekli Kendinden Koku Gidericili Fileli Süzgeç Takım	20	22,85
YAF64	15 x 15 Yan Çıkış Ø32 İzolasyon Etekli Kendinden Koku Gidericili Fileli Süzgeç Takım	20	29,50
YAF65	15 x 15 Yan Çıkış Ø50 İzolasyon Etekli Kendinden Koku Gidericili Fileli Süzgeç Takım	20	29,50
YAF66	15 x 15 Yan Çıkış Ø75 İzolasyon Etekli Kendinden Koku Gidericili Fileli Süzgeç Takım	20	29,50

\* Paslanmaz flanş fiyata dahil değildir.

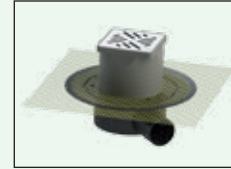

YAF10 10x10 - Ø50 Yan Çıkışlı

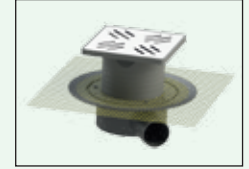

YAF15 15x15 - Ø50 Yan Çıkışlı



YAF21 10x10 - Ø50 Alt Çıkışlı



YAF23 10x10 - Ø75 Alt Çıkışlı

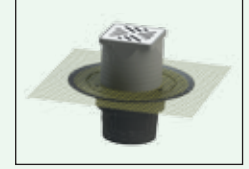

YAF25 10x10 - Ø110 Alt Çıkışlı



YAF22 15x15 - Ø50 Alt Çıkışlı



YAF24 15x15 - Ø75 Alt Çıkışlı

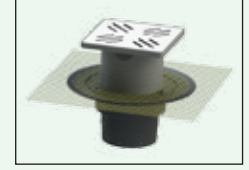

YAF26 15x15 - Ø110 Alt Çıkışlı

## Klape ve Koku Gidericili Membranlı - Yalıtım Etekli Yükseklik Ayarlı Süzgeçler

**4531**

Kod	Ürün Adı	Amb.	Fiyat
YAM10	10 x 10 - Yan Çıkış Ø50 Membranlı - Yalıtım Etekli Süzgeç Takım	20	49,76
YAM15	15 x 15 - Yan Çıkış Ø50 Membranlı - Yalıtım Etekli Süzgeç Takım	20	56,42
YAM21	10 x 10 - Alt Çıkış Ø50 Membranlı - Yalıtım Etekli Süzgeç Takım	20	47,57
YAM22	15 x 15 - Alt Çıkış Ø50 Membranlı - Yalıtım Etekli Süzgeç Takım	20	54,23
YAM23	10 x 10 - Alt Çıkış Ø75 Membranlı - Yalıtım Etekli Süzgeç Takım	20	47,57
YAM24	15 x 15 - Alt Çıkış Ø75 Membranlı - Yalıtım Etekli Süzgeç Takım	20	54,23
YAM25	10 x 10 - Alt Çıkış Ø110 Membranlı - Yalıtım Etekli Süzgeç Takım	20	47,57
YAM26	15 x 15 - Alt Çıkış Ø110 Membranlı - Yalıtım Etekli Süzgeç Takım	20	54,23

Kod	Ürün Adı	Amb.	Fiyat
YAM61	10 x 10 Yan Çıkış Ø32 İzolasyon Etekli Kendinden Koku Gidericili Membranlı Süzgeç Takım	20	46,36
YAM62	10 x 10 Yan Çıkış Ø50 İzolasyon Etekli Kendinden Koku Gidericili Membranlı Süzgeç Takım	20	46,36
YAM63	10 x 10 Yan Çıkış Ø75 İzolasyon Etekli Kendinden Koku Gidericili Membranlı Süzgeç Takım	20	46,36
YAM64	15 x 15 Yan Çıkış Ø32 İzolasyon Etekli Kendinden Koku Gidericili Membranlı Süzgeç Takım	20	53,02
YAM65	15 x 15 Yan Çıkış Ø50 İzolasyon Etekli Kendinden Koku Gidericili Membranlı Süzgeç Takım	20	53,02
YAM66	15 x 15 Yan Çıkış Ø75 İzolasyon Etekli Kendinden Koku Gidericili Membranlı Süzgeç Takım	20	53,02

\* Paslanmaz flanş fiyata dahildir.



YAM10 10x10 - Ø50 Yan Çıkışlı



YAM15 15x15 - Ø50 Yan Çıkışlı



YAM21 10x10 - Ø50 Alt Çıkışlı



YAM23 10x10 - Ø75 Alt Çıkışlı



YAM25 10x10 - Ø110 Alt Çıkışlı



YAM22 15x15 - Ø50 Alt Çıkışlı



YAM24 15x15 - Ø75 Alt Çıkışlı



YAM26 15x15 - Ø110 Alt Çıkışlı

## Klape ve Koku Gidericili Tekstil Membranlı - Yalıtım Etekli Yükseklik Ayarlı Süzgeçler

**4541**

Kod	Ürün Adı	Amb.	Fiyat
YAT10	10 x 10 - Yan Çıkış Ø50 Tekstil Membranlı - Yalıtım Etekli Süz. Takım	20	49,76
YAT15	15 x 15 - Yan Çıkış Ø50 Tekstil Membranlı - Yalıtım Etekli Süz. Takım	20	56,42
YAT21	10 x 10 - Alt Çıkış Ø50 Tekstil Membranlı - Yalıtım Etekli Süz. Takım	20	47,57
YAT22	15 x 15 - Alt Çıkış Ø50 Tekstil Membranlı - Yalıtım Etekli Süz. Takım	20	54,23
YAT23	10 x 10 - Alt Çıkış Ø75 Tekstil Membranlı - Yalıtım Etekli Süz. Takım	20	47,57
YAT24	15 x 15 - Alt Çıkış Ø75 Tekstil Membranlı - Yalıtım Etekli Süz. Takım	20	54,23
YAT25	10 x 10 - Alt Çıkış Ø110 Tekstil Membranlı - Yalıtım Etekli Süz. Takım	20	47,57
YAT26	15 x 15 - Alt Çıkış Ø110 Tekstil Membranlı - Yalıtım Etekli Süz. Takım	20	54,23

Kod	Ürün Adı	Amb.	Fiyat
YAT61	10 x 10 Yan Çıkış Ø32 İzolasyon Etekli Kendinden Koku Gidericili Tekstil Membranlı Süzgeç Takım	20	46,36
YAT62	10 x 10 Yan Çıkış Ø50 İzolasyon Etekli Kendinden Koku Gidericili Tekstil Membranlı Süzgeç Takım	20	46,36
YAT63	10 x 10 Yan Çıkış Ø75 İzolasyon Etekli Kendinden Koku Gidericili Tekstil Membranlı Süzgeç Takım	20	46,36
YAT64	15 x 15 Yan Çıkış Ø32 İzolasyon Etekli Kendinden Koku Gidericili Tekstil Membranlı Süzgeç Takım	20	53,02
YAT65	15 x 15 Yan Çıkış Ø50 İzolasyon Etekli Kendinden Koku Gidericili Tekstil Membranlı Süzgeç Takım	20	53,02
YAT66	15 x 15 Yan Çıkış Ø75 İzolasyon Etekli Kendinden Koku Gidericili Tekstil Membranlı Süzgeç Takım	20	53,02

\* Paslanmaz flanş fiyata dahildir.



YAT10 10x10 - Ø50 Yan Çıkışlı

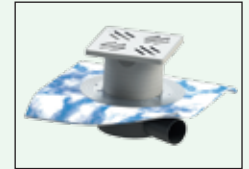

YAT15 15x15 - Ø50 Yan Çıkışlı



YAT21 10x10 - Ø50 Alt Çıkışlı

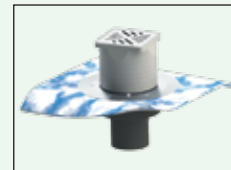

YAT23 10x10 - Ø75 Alt Çıkışlı

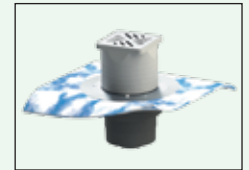

YAT25 10x10 - Ø110 Alt Çıkışlı



YAT22 15x15 - Ø50 Alt Çıkışlı



YAT24 15x15 - Ø75 Alt Çıkışlı



YAT26 15x15 - Ø110 Alt Çıkışlı

## Lineer Duş Kanalı S Sifonu

**1046**

Ürün Kod	Ölçü	Ambalaj	Fiyat
PSE21	110/50	1	26,05

\* Çıkış çapı Ø40 veya Ø50

## Lineer Duş Kanalları HighLine Serisi

**4900**

Kod	Ürün Adı	Ambalaj	Fiyat
LDH30	HL Lineer Duş Kanalı 30 cm	1	250,00
LDH45	HL Lineer Duş Kanalı 45 cm	1	270,00
LDH55	HL Lineer Duş Kanalı 55 cm	1	315,00
LDH65	HL Lineer Duş Kanalı 65 cm	1	345,00
LDH85	HL Lineer Duş Kanalı 85 cm	1	435,00

## TopLine Lineer Duş Kanalı (Paslanmaz Çerçevesi ve Seramik Uyumlu)

**4901**

Ürün Kod	Ölçü	Ambalaj	Fiyat
LTS05	TopLine Lineer Duş Kanalı 60 cm	1	201,52
LTS06	TopLine Lineer Duş Kanalı 80 cm	1	225,76

\* Çıkış çapı Ø40 veya Ø50

## TopLine Lineer Duş Kanalı (Plastik Çerçevesi)

**4901**

Ürün Kod	Ölçü	Ambalaj	Fiyat
LTS15	TopLine Lineer Duş Kanalı (Plastik Çerçevesi) 60 cm	1	137,50
LTS16	TopLine Lineer Duş Kanalı (Plastik Çerçevesi) 80 cm	1	157,50

\* Çıkış çapı Ø40 veya Ø50

## Lineer Duş Kanalları ComfortLine Serisi

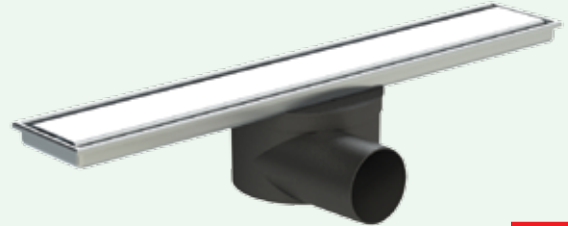
**4856**

Kod	Ürün Adı	Ambalaj	Fiyat
LCD14	ComfortLine Ø32 Yan Çıkış 40 cm	20	153,85
LCD15	ComfortLine Ø32 Yan Çıkış 50 cm	20	167,95
LCD16	ComfortLine Ø32 Yan Çıkış 60 cm	20	182,05
LCD34	ComfortLine Ø50 Yan Çıkış 40 cm	20	153,85
LCD35	ComfortLine Ø50 Yan Çıkış 50 cm	20	167,95
LCD36	ComfortLine Ø50 Yan Çıkış 60 cm	20	182,05

## Lineer Duş Kanalları ComfortLine Serisi

**4857**

Kod	Ürün Adı	Amb.	Fiyat
LCF14	ComfortLine Ø32 Yan Çıkış İzolasyon Fileli 40 cm	20	160,26
LCF15	ComfortLine Ø32 Yan Çıkış İzolasyon Fileli 50 cm	20	174,36
LCF16	ComfortLine Ø32 Yan Çıkış İzolasyon Fileli 60 cm	20	188,46
LCF34	ComfortLine Ø50 Yan Çıkış İzolasyon Fileli 40 cm	20	160,26
LCF35	ComfortLine Ø50 Yan Çıkış İzolasyon Fileli 50 cm	20	174,36
LCF36	ComfortLine Ø50 Yan Çıkış İzolasyon Fileli 60 cm	20	188,46

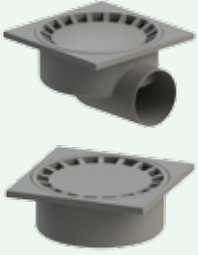

**Bahçe ve Balkon Süzgeçleri**
**4932**

Ürün Kod	Ölçü	Ambalaj	Fiyat
BBS23	15x15 Yan Çıkışlı Ø50	36	3,95
BBS33	20x20 Alt Çıkışlı Ø50	18	11,37
BBS34	20x20 Alt Çıkışlı Ø75	18	11,51
BBS44	20x20 Yan Çıkışlı Ø75	18	9,41
BBS55	25x25 Alt Çıkışlı Ø110	14	14,63
BBS65	25x25 Yan Çıkışlı Ø110	11	18,80

**Bitümlü Membran Uyumlu Dik İnşili İzolasyon Süzgeci**
**4941**

Ürün Kod	Çap Ø	Ambalaj	Fiyat
MDS01	50	30	9,98
MDS03	75	40	11,66
MDS04	110	30	13,43
MDS05	125	18	15,34
MDS06	160	12	20,56

**Süzgeçten Dik İzolasyon Süzgecine Geçiş Adaptörü**

**4941**

Ürün Kod	Çap Ø	Ambalaj	Fiyat
MDS11	50	1	3,30
MDS12	75	1	3,52
MDS13	110	1	3,74

**Bitümlü Membran Uyumlu Parapet Çıkışlı İzolasyon Süzgeci**
**4941**

Ürün Kod	Çap Ø	Ambalaj	Fiyat
MDS03	75	25	11,16
MDS04	110	20	13,43

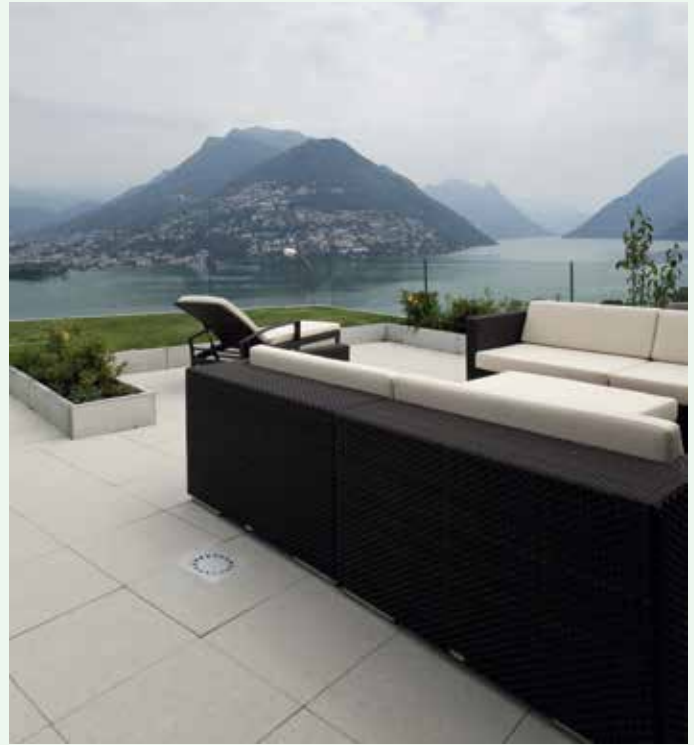
**Yaprak Tutucu Ahtapot Süzgeç**
**4951**

Ürün Kod	Ölçü	Ambalaj	Fiyat
YPT03	50 - 110 Çaplara Uyumlu	100	5,95
YPT04	75 - 160 Çaplara Uyumlu	120	6,58

**Flanş Uyumlu Yaprak Tutucu**
**4952**

Ürün Kod	Ölçü	Ambalaj	Fiyat
FYP01	Flanş Uyumlu Yaprak Tutucu	100	5,76

**Körüklü Sifon**
**4960**

Ürün Kod	Ölçü	Ambalaj	Fiyat
KSU01	Uzun Körüklü Sifon	75	7,11
KSK11	Kısa Körüklü Sifon	125	5,26
KSC21	Çamaşır Bağlantılı Körüklü Sifon	50	6,36

**Troplen**
**4961**

Ürün Kod	Ölçü	Ambalaj	Fiyat
DST01	Duş Tropleni	50	14,85

**Perde Tipi Plastik Paspayı Elemanları**
**3941**

Ürün kod	Paspayı Yükseklik (mm)	Demir Çap Ø - mm	Ambalaj	Fiyat
PKP01	15	6 - 12	3000	<b>0,098</b>
PKP02	20	6 - 12	2500	<b>0,099</b>
PKP03	25	6 - 14	2000	<b>0,101</b>
PKP04	30	8 - 12	1000	<b>0,154</b>
PKP05	40	12 - 16	1000	<b>0,237</b>
PKP06	50	8 - 16	500	<b>0,426</b>
PKP07	75	6 - 22	250	<b>1,018</b>

**Norm (Ağır) Tipi Plastik Paspayı Elemanları**
**3943**

Ürün kod	Paspayı Yükseklik (mm)	Demir Çap Ø - mm	Ambalaj	Fiyat
NDP01	20	8 - 24	1000	<b>0,152</b>
NDP02	25	8 - 24	1000	<b>0,136</b>
NDP03	30	8 - 24	1000	<b>0,201</b>
NDP04	40	8 - 24	1000	<b>0,237</b>
NDP05	50	8 - 24	500	<b>0,249</b>
NDP07	75	20 - 32	250	<b>0,924</b>

**Mandal Tipi Döşeme Plastik Paspayı Elemanları**
**3944**

Ürün kod	Paspayı Yükseklik (mm)	Demir Çap Ø - mm	Ambalaj	Fiyat
MTP01	15	8 - 12	2500	<b>0,111</b>
MTP02	20	6 - 14	2500	<b>0,124</b>
MTP03	25	6 - 14	2500	<b>0,142</b>
MTP04	30	6 - 14	2000	<b>0,178</b>
MTP05	75	10 - 20	500	<b>0,509</b>

**Sehpalı Norm (Ağır) Tip Plastik Paspayı Elemanları**
**3945**

Ürün kod	Paspayı Yükseklik (mm)	Demir Çap Ø - mm	Ambalaj	Fiyat
SHP01	25	8 - 24	1000	<b>0,616</b>
SHP02	30	8 - 24	1000	<b>0,663</b>
SHP03	40	8 - 24	1000	<b>0,699</b>
SHP04	50	8 - 24	500	<b>0,699</b>
SHP05	75	20 - 32	250	<b>1,658</b>

**Paralel Plastik Paspayı Elemanları**
**3947**

Ürün kod	Paspayı Yükseklik (mm)	Demir Çap Ø - mm	Ambalaj	Fiyat
PDP02	20	20 x 215	500	<b>0,639</b>
PDP03	25	25 x 215	500	<b>0,699</b>
PDP04	30	30 x 215	500	<b>0,758</b>

**Profil Tip Döşeme Paspayı**
**3952**

Ürün kod	Paspayı Yükseklik (mm)	Demir Çap Ø - mm	Ambalaj	Fiyat
PTP01	25	-	100	<b>1,658</b>
PTP02	40	-	100	<b>2,250</b>

**Döşeme ve Perde Tipi Plastik Paspayı Elemanları**
**3942**

Ürün kod	Paspayı Yükseklik (mm)	Demir Çap Ø - mm	Ambalaj	Fiyat
DPP01	25	6 - 18	2000	<b>0,284</b>
DPP02	30	6 - 18	2000	<b>0,343</b>

**Fore Kazık Plastik Paspayı Elemanı**
**3948**

Ürün kod	Paspayı Yükseklik (mm)	Demir Çap Ø - mm	Ambalaj	Fiyat
FKP01	50	8 - 12	150	<b>1,089</b>
FKP02	75	8 - 12	100	<b>2,250</b>

**Çember Tipi Plastik Paspayı Elemanları**
**3946**

Ürün kod	Paspayı Yükseklik (mm)	Demir Çap Ø - mm	Ambalaj	Fiyat
CEP01	15	150	1000	<b>0,367</b>
CEP02	20	200	500	<b>0,651</b>

**Koruyucu Konik**
**3981**

Ürün kod	Paspayı Yükseklik (mm)	Demir Çap Ø - mm	Ambalaj	Fiyat
KRK02	20	20	100	<b>8,053</b>
KRK03	25	20	100	<b>8,289</b>
KRK04	30	20	100	<b>8,645</b>





**Tei-Rot (Saplama) Boruları**
**3971**

Ürün kod	Boru İç Çapı mm	Boru Dış Çapı mm	Boy	Ambalaj	Fiyat
DYB01	18	22	3mt	150	1,946
DYB02	22	25	3mt	150	1,946
DYB03	28	32	3mt	99	4,622

**Tei-Rot (Saplama) Boru Başlığı**
**3972**



Ürün kod	Delik İç Çapı	Boru Dış Çapı	Ambalaj	Fiyat
DBB01	18	22	3000	0,146
DBB02	22	26	2000	0,103
DBB03	28	32	1000	0,438

**PAH Üçgen Profilleri**
**3961**

Ürün kod	Paspayı	Yükseklik	Demir Çap Ø - mm	Ambalaj	Fiyat
KLC01	15 x 15	Kulaklı L=3mt	22	150	1,520
KLC02	20 x 18	Kulaklı L=3mt	30	150	2,068
KLC03	35 x 20	Kulaklı L=3mt	50	60	4,986
KSC11	20 x 15	Kulaksız L=3mt	22	150	1,520
KSC12	30 x 20	Kulaksız L=3mt	30	150	1,824
KSC13	35 x 25	Kulaksız L=3mt	35	150	2,919
KSC14	50 x 35	Kulaksız L=3mt	50	75	4,622

**Fuga Çıtaları**
**3962**

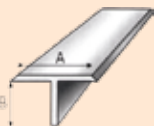
Ürün kod	A	B	C	Boy	Ambalaj	Fiyat
FGC01	30	20	15	3 mt	150	2,919
FGC02	50	10	20	3 mt	75	4,622

**T Profili**
**3963**

Ürün kod	A	H	Ambalaj	Fiyat
TPR01	30	15	150	1,764

**Yer Altı Buat Kapaklı Kutular**
**20 Kutu**
**4201**

Ürün Kod	Ürün Adı	Ambalaj	Fiyat
RGR20	20 Kapaklı Kutu	1	24,82
RGR21	20 Kapaksız Kutu	1	14,22

**30 Kutu**
**4202**

Ürün Kod	Ürün Adı	Ambalaj	Fiyat
RGR30	30 Kapaklı Kutu	1	47,65
RGR31	30 Kapaksız Kutu	1	33,61

**40 Kutu**
**4203**

Ürün Kod	Ürün Adı	Ambalaj	Fiyat
RGR40	40 Kapaklı Kutu	1	81,80
RGR41	40 Kapaksız Kutu	1	60,92

**55 Kutu**
**4205**



Ürün Kod	Ürün Adı	Ambalaj	Fiyat
RGR55	55 Kapaklı Kutu	1	253,62
RGR56	55 Kapaksız Kutu	1	206,09

**48 Kutu**
**4206**

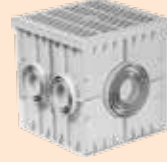

Ürün Kod	Ürün Adı	Ambalaj	Fiyat
RGR48	48 Kapaklı Kutu	1	216,39
RGR49	48 Kapaksız Kutu	1	174,08

**36 Kutu 6 Çıkışlı**
**4209**

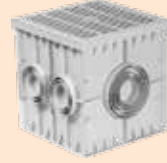

Ürün Kod	Ürün Adı	Ambalaj	Fiyat
RGR36	6 Çıkışlı 36 Kapaklı Kutu	1	142,15
RGR37	6 Çıkışlı 36 Kapaksız Kutu	1	96,44

**30 Kutu 6 Çıkışlı**
**4212**

Ürün Kod	Ürün Adı	Ambalaj	Fiyat
RGR32	6 Çıkışlı 30 Kapaklı Kutu	1	69,17
RGR33	6 Çıkışlı 30 Kapaksız Kutu	1	54,13

**40 Kutu 6 Çıkışlı**
**4213**

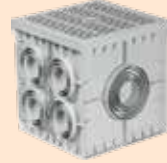
Ürün Kod	Ürün Adı	Ambalaj	Fiyat
RGR42	6 Çıkışlı 40 Kapaklı Kutu	1	127,96
RGR43	6 Çıkışlı 40 Kapaksız Kutu	1	94,12

**55 Kutu 10 Çıkışlı**
**4214**

Ürün Kod	Ürün Adı	Ambalaj	Fiyat
RGR57	10 Çıkışlı 55 Kapaklı Kutu	1	369,68
RGR58	10 Çıkışlı 55 Kapaksız Kutu	1	300,44

**Muayene Bacası 1000**
**6995**

Ürün Kod	Ölçü	Ambalaj	Fiyat
MYB02	150 mm Korige Boru Uyumlu	1	2.048,78
MYB03	200 mm Korige Boru Uyumlu	1	2.074,07
MYB04	250 mm Korige Boru Uyumlu	1	2.100,00
MYB05	300 mm Korige Boru Uyumlu	1	2.126,58

**Döküm Rögar Kapak 600**
**6996**

Ürün Kod	Ölçü	Fiyat
RDK03	Rögar Kapak C250	1.078,95
RDK04	Rögar Kapak D400	1.210,53

**Kompozit Rögar Kapak 600**
**6997**

Ürün Kod	Ölçü	Fiyat
RKK02	Rögar Kapak B125 Kompozit	921,05
RKK04	Rögar Kapak D400 Kompozit	1.120,00

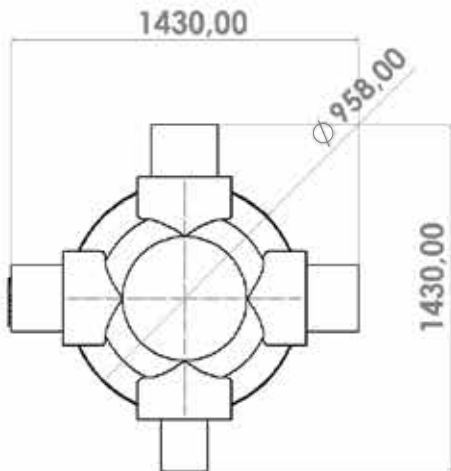
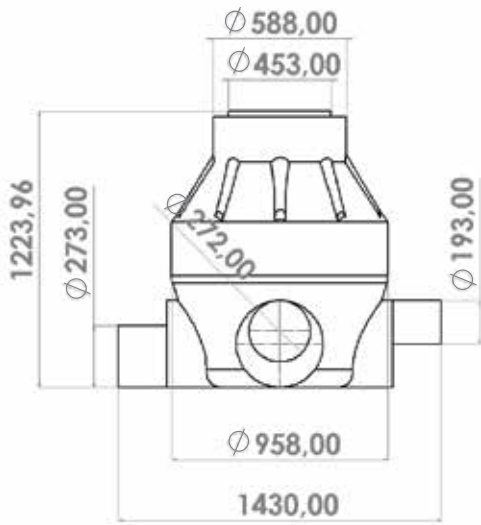

## 600 Muayene Bacası

6698

Kod	Ölçü	Ambalaj	Fiyat
MBA03	200 mm Korige Boru Uyumlu	1	1.381,58

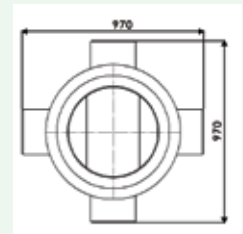
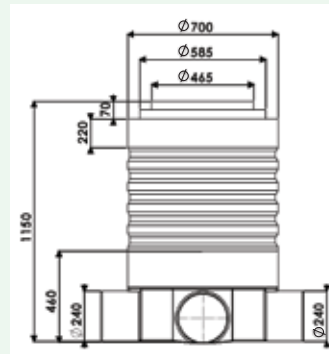
**YENİ**

## 500 Muayene Bacası (Koruge ve Pis Su Boru Uyumlu)

6990



Koruge ve Pis Su Boru uyumlu Rogar kutusu dış çap ölçüsü 530 mm'dir.  
 400 koruge boru bağlantısı ile yükseklik ayarlayabilme imkanı vardır.  
 Taban çıkışları 150 koruge boru ve 160,125,110, pis su boru montajına uygundur.  
 Ayrıca 100,75,63 ve 50 mm data kablo muhafaza borusu montajına da uyumludur.  
 Su sızdırmaz conta yuvalı 4 girişinin dışında 8 adette data borusuna uygun toplamda 12 adet girişi mevcuttur.



Ürün Kod	Ölçü	Ambalaj	Fiyat
MBT06	Koruge Boru Uyumlu Muayene Bacası Kapaklı Takım 150 mm Koruge Boru, 110 - 160 mm Pis Su Boru	1	128,79

## 500 Muayene Baca Tabanı

6991

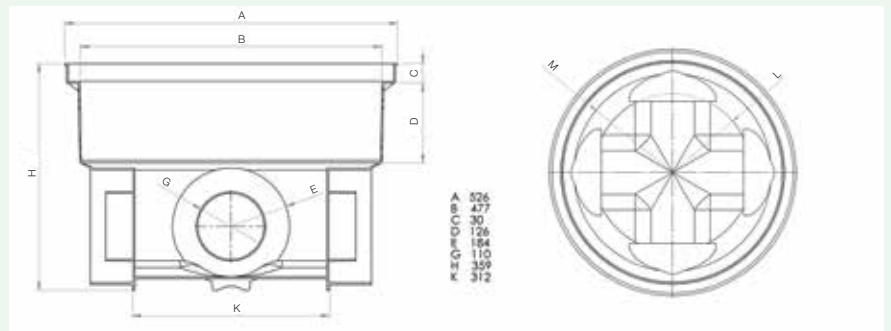

Ürün Kod	Ölçü	Yükselti Şaft Boru Çapı	Alt Boru Bağlantı Çapları	Ambalaj	Fiyat
MBG06	Koruge Boru Uyumlu Muayene Baca Tabanı	400	150 mm Koruge Boru, 110-160 mm Pis Su Borusu	1	94,55

## 500 Muayene Bacası Kapak ve Çerçevesi

6992

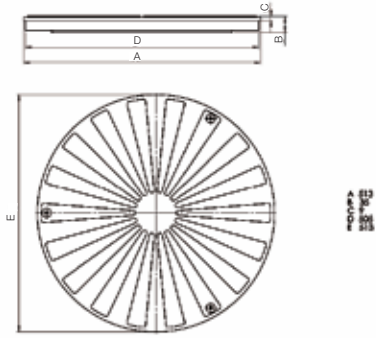

Muayene Baca Kapak Ölçüsü

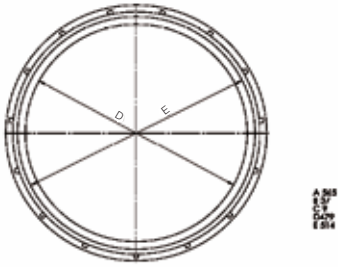

Muayene Baca Kapak Çerçeve Ölçüsü

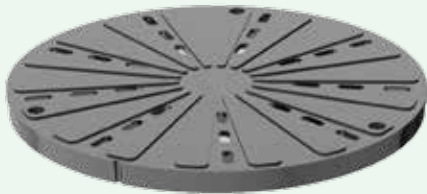

MBK26

Yuvarlak Izgaralı Kapak 600



MBK06

Yuvarlak Düz Kapak 600



MBC56

Yuvarlak Kapak Çerçevesi 600



MBK36

Çerçevesi Yuvarlak Düz Kapak Takım 600



MBK46

Çerçevesi Yuvarlak Izgara Kapak Takım 600

Ürün Kod	Ölçü	Ambalaj	Fiyat
MBK36	Çerçevesi Yuvarlak Düz Kapak Takım 600	1	70,93
MBK46	Çerçevesi Yuvarlak Izgara Kapak Takım 600	1	70,86
MBK06	Yuvarlak Düz Kapak 600	1	52,42
MBK26	Yuvarlak Izgara Kapak 600	1	52,31
MBK66	Yuvarlak Yeşil Düz Kapak 600	1	58,99
MBK76	Yuvarlak Yeşil Izgara Kapak 600	1	58,99
MBC56	Yuvarlak Kapak Çerçevesi 600	1	18,52

**Drenaj Borusu**
**6201**

Ürün Kod	Çap Ø	Ambalaj	Fiyat
DRJ01	80	100	9,88
DRJ02	100	100	9,53
DRJ03	125	100	16,93
DRJ04	150	50	21,05
DRJ05	200	50	28,95

**Geotekstil Sarılı Drenaj Borusu**
**6202**

Ürün Kod	Çap Ø	Ambalaj	Fiyat
DRG02	100	100	18,42
DRG03	125	100	26,32
DRG04	160	50	32,89
DRG05	200	50	42,11

**Drenaj Şiltesi**
**6221**



Gram	GRI Kod	Fiyat	BEYAZ Kod	Fiyat
100	DSG01		DSB11	1,67
150	DSG02	1,49	DSB12	1,93
200	DSG03	2,00	DSB13	2,57
250	DSG04	2,49	DSB14	3,20
300	DSG05	3,00	DSB15	3,86
400	DSG06	4,00	DSB16	5,14

**Drenaj Manşon**
**6211**

Ürün Kod	Çap Ø	Ambalaj	Fiyat
DRJ11	80	1	4,86
DRJ12	100	1	3,59
DRJ13	125	1	15,22
DRJ14	150	1	18,33
DRJ15	200	1	31,17

**Data Kablo Muhafaza Borusu**
**6232**

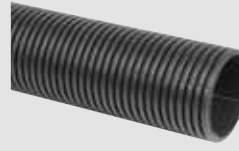
Ürün Kod	Boru İç Çapı mm	Boru Dış Çapı mm	Fiyat
DTB01	96	100	7,44
DTB02	100	115	8,08

**Çift ve Tek Cıdarlı Kılıf Borusu**
**6231**

Ürün Kod	Boru İç Çapı mm	Boru Dış Çapı mm	Ürün	Ambalaj	Fiyat
CKB01	42	50	Kangal	100	5,58
CKB02	57	63	Kangal	100	6,45
CKB03	65	75	Kangal	100	7,49

**Data Manşon**
**6241**

Ürün Kod	Ölçü	Ambalaj	Fiyat
DTB20	100 (Tırmaklı)	30	2,44
DTB21	115	20	2,73

**Data Conta**
**6241**

Ürün Kod	Ölçü	Ambalaj	Fiyat
DTB24	115	2000	0,77

**Data Destek**
**6241**

Ürün Kod	Ölçü	Ambalaj	Fiyat
DTB22	115	100	1,96
DTB23	100	150	1,96

**Data Tapa**
**6241**

Ürün Kod	Ölçü	Ambalaj	Fiyat
DTB25	115	20	17,84

**Data Adaptör**
**6241**

Ürün Kod	Ölçü	Ambalaj	Fiyat
DTB26	115	15	23,84





## PE 100 Polietilen Boru

Boru Çapı mm	6411		6421		6431	
	PN10 Ürün Kod	\$/m	PN16 Ürün Kod	\$/m	PN20 Ürün Kod	\$/m
20	PEA01	Fiyat Sorunuz	PEB01	0,82	PEC01	*
25	PEA02	0,96	PEB02	1,25	PEC02	*
32	PEA03	1,40	PEB03	1,96	PEC03	*
40	PEA04	2,21	PEB04	3,14	PEC04	*
50	PEA05	3,45	PEB05	5,02	PEC05	*
63	PEA06	5,40	PEB06	7,75	PEC06	*
75	PEA07	7,78	PEB07	10,98	PEC07	*
90	PEA08	10,95	PEB08	15,65	PEC08	*
110	PEA09	16,05	PEB09	22,95	PEC09	*
125	PEA10	*	PEB10	*	PEC10	*
140	PEA11	*	PEB11	*	PEC11	*
160	PEA12	*	PEB12	*	PEC12	*
180	PEA13	*	PEB13	*	PEC13	*
200	PEA14	*	PEB14	*	PEC14	*
225	PEA15	*	PEB15	*	PEC15	*
250	PEA16	*	PEB16	*	PEC16	*
280	PEA17	*	PEB17	*	PEC17	*
315	PEA18	*	PEB18	*	PEC18	*
355	PEA19	*	PEB19	*	PEC19	*
400	PEA20	*	PEB20	*	PEC20	*

## SDR17-PN10

Çap	S	Kg/m
20		
25	2,00	0,15
32	2,00	0,19
40	2,40	0,28
50	3,00	0,44
63	3,80	0,70
75	4,50	0,99
90	5,40	1,42
110	6,60	2,11
125	7,40	2,69
140	8,30	3,38
160	9,50	4,42
180	10,70	5,60
200	11,90	6,92
225	13,40	8,77
250	14,80	10,76
280	16,60	13,52
315	18,70	17,13
355	21,10	21,78
400	23,70	27,56
450	26,70	34,93
500	29,70	43,17

## SDR11-PN16

S	Kg/m
2,00	0,12
2,40	0,17
3,00	0,27
3,70	0,42
4,60	0,65
5,80	1,03
6,80	1,44
8,20	2,08
10,00	3,10
11,40	4,01
12,70	5,00
14,60	6,57
16,40	8,30
18,20	10,23
20,50	12,96
22,70	15,95
25,40	19,99
28,60	25,32
32,20	32,13
36,30	40,80
40,90	51,71
45,40	63,78

## SDR9-PN20

S	Kg/m
2,30	0,13
3,00	0,21
3,60	0,32
4,50	0,50
5,60	0,77
7,10	1,23
8,40	1,73
10,10	2,50
12,30	3,72
14,00	4,81
15,70	6,04
17,90	7,87
20,10	9,94
22,40	12,30
25,20	15,56
27,90	19,15
31,30	24,06
35,20	30,44
39,70	38,69
44,70	49,08
50,30	62,13
55,80	76,60

PE 100 Boru Fiyatlarımız Dolar'dır (\$) \* Fiyat Sorunuz.

TS 418-2 EN 12201-2



### Kangal Boru Kamyon Metrajları

Çap	Metre
20	36000
25	18000
32	12000
40	8800
50	2700
63	2400
75	1300
90	1200
110	1000

Fiyatlarımız Dolar'dır. (\$) Nakliye alıcıya aittir.

Nakliye dahil fiyatımız metraj ve gideceği mesafeye göre değişkendir.

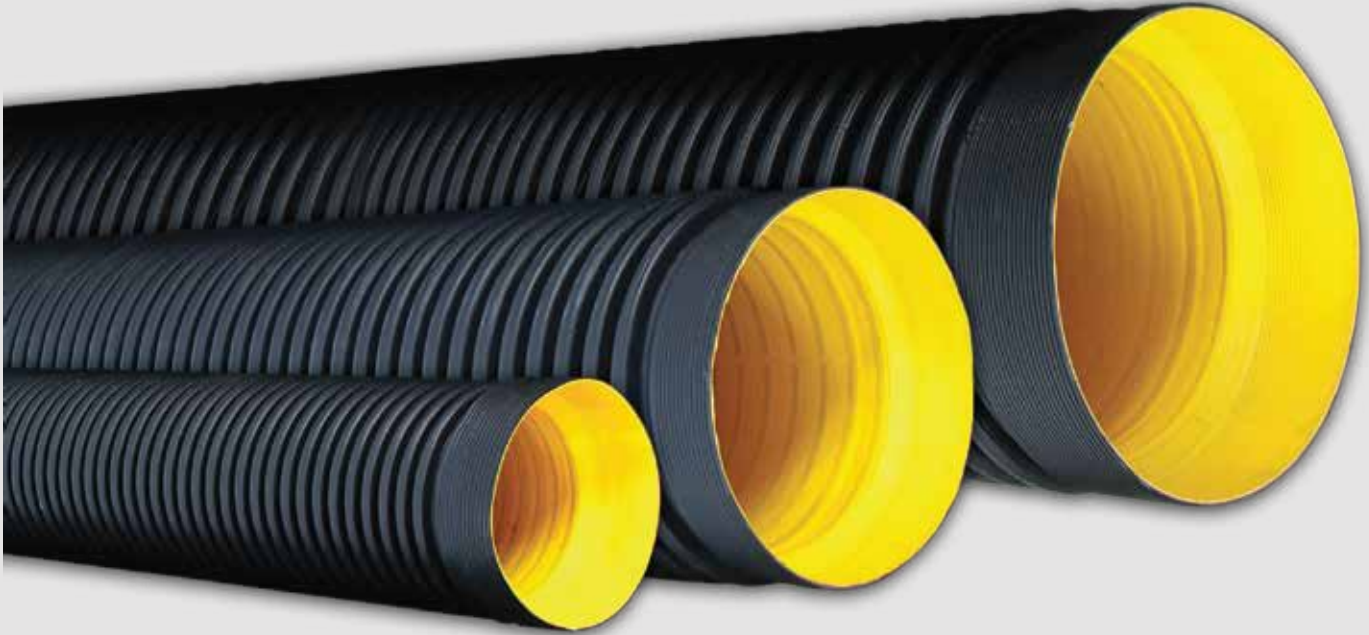
**Korige Boru Kendinden Muflu SN4**
**6821**

Ürün Kod	Ölçü (Ø)	Fiyat
KRG42	150	20,28
KRG43	200	32,93
KRG45	300	73,01
KRG47	400	126,20
KRG49	500	220,47
KRG50	600	333,84
KRG52	800	618,10
KRG54	1000	1.111,53

**Korige Boru Kendinden Muflu SN8**
**6831**

Ürün Kod	Ölçü (Ø)	Fiyat
KRG81	100	12,71
KRG82	150	27,61
KRG83	200	45,77
KRG85	300	106,01
KRG87	400	194,04
KRG89	500	282,81
KRG90	600	451,18
KRG92	800	755,60
KRG94	1000	1.379,19

**Korige Boru**
**6801**

Ürün Kod	Ölçü (Ø)	Fiyat
KRA41	100* Mufszuz Korige	9,84

**Korige Boru Kamyon Metrajları**

Çap	Metre
100	3000
150	1500
200	750
250	510
300	330
400	180
500	120
600	90
800	54

**Fiyatlarımız TL'dir.**  
**Nakliye alıcıya aittir.**

Nakliye dahil fiyatımız metraj ve gideceği mesafeye göre değişkendir.



**Korige Manşon**
**6901**

Ürün Kod	Ölçü (Ø)	Fiyat
KRG12	100 *	3,26
KRG13	150 *	9,49
KRG14	200 *	14,98
KRM15	250	32,28
KRM16	300	56,28
KRM18	400	97,46
KRM20	500	600,64
KRM21	600	869,88
KRM23	800	1.574,08
KRM25	1000	12.792,40

**Korige Conta**
**6911**

Ürün Kod	Ölçü (Ø)	Fiyat
KRC01	100 *	1,05
KRC02	150 *	3,36
KRC03	200 *	7,27
KRC05	300 *	24,79
KRC07	400 *	68,46
KRC09	500 *	74,35
KRC10	600 *	166,49
KRC12	800 *	323,03
KRC14	1000 *	699,24

**Korige Açık Dirsek 45°**
**6921**

Ürün Kod	Ölçü (Ø)	Fiyat
KRG32	100 *	15,63
KRG33	150 *	22,43
KRG34	200 *	44,88
KRG35	250	102,34
KRG36	300	140,84
KRG38	400	389,86
KRG40	500	789,48

**Korige Kapalı Dirsek 90°**
**6922**

Ürün Kod	Ölçü (Ø)	Fiyat
KRG22	100 *	17,43
KRG23	150 *	30,27
KRG24	200 *	50,26
KRG25	250	175,44
KRG26	300	268,04
KRG28	400	545,80
KRG30	500	1.713,84

**Korige C Parçası Pis Su Boru Çıkışı**
**6930**

Ürün Kod	Ölçü (Ø)	Fiyat
CTL01	100/110 *	44,68
CTL02	150/110	56,91
CTL04	150/160 *	36,76
CTL05	200/110 *	68,42
CTL07	200/160 *	81,68
CTL14	300/160	259,09

**Korige C Parçası Korige Çıkışı**
**6931**

Ürün Kod	Ölçü (Ø)	Fiyat
CTL31	100/100 *	46,40
CTL35	300/200	202,86

**Korige TE Parçası (Korige Çıkışı 87°)**
**6940**

Ürün Kod	Ölçü (Ø)	Fiyat
KTE01	100/100 Korige Boru Çıkışı *	46,38
KTE09	200/200 Korige Boru Çıkışı *	88,47

**Korige Te Parçası (Pis Su Boru Çıkışı 87°)**
**6941**

Ürün Kod	Ölçü (Ø)	Fiyat
KTE31	100/110 Pis Su Boru Çıkışı *	58,48

**Korige'den Pis Suya Geçiş Adaptörü**
**6925**

Ürün Kod	Ölçü (Ø)	Fiyat
KRG62	100/110 *	9,25
KRG63	150/160 *	17,14

- Listemizde bulunan korige ek parçaları enjeksiyon imalattır.
- Konfeksiyon korige ek parça özel imalatımız da vardır.
- Listede olmayan Korige ek parçaları için fiyat isteyiniz.

**Fiyatlarımız TL'dir.**  
**Nakliye alıcıya aittir.**

Nakliye dahil fiyatımız metraj ve gideceği mesafeye göre değişkendir.

## PVC Basınçlı Temiz Su Boru ve Ek Parçaları

Anma Çapı	Dış Çap	Inch	6301		6302		6304		6306		6311		6321		6371	
			4 ATÜ Ürün Kod	Fiyat	6 ATÜ Ürün Kod	Fiyat	10 ATÜ Ürün Kod	Fiyat	16 ATÜ Ürün Kod	Fiyat	CONTA Ürün Kod	Fiyat	MANŞON Ürün Kod	Fiyat	ADAPTÖR Ürün Kod	Fiyat
15	20	1/2"	TSA01	*	TSA21	*	TSB01	4,99	TSA41	4,46			TSM01	1,81		
20	25	3/4"	TSA02	*	TSA22	*	TSB02	5,66	TSA42	7,03			TSM02	2,24		
25	32	1"	TSA03	*	TSA23	*	TSB03	7,89	TSA43	11,31			TSM03	2,56		
32	40	1 1/4"	TSA04	*	TSA24	*	TSB04	10,46	TSA44	15,43			TSM04	3,88		
40	50	1 1/2"	TSA05	*	TSA25	10,63	TSB05	15,94	TSA45	23,83	TSC05	0,81	TSM05	7,20	TAD05	16,20
50	63	2"	TSA06	*	TSA26	16,29	TSB06	24,86	TSA46	37,20	TSC06	1,03	TSM06	12,60	TAD06	18,90
65	75	2 1/2"	TSA07	*	TSA27	22,46	TSB07	35,31	TSA47	52,97	TSC07	1,25	TSM07	19,80	TAD07	25,20
80	90	3"	TSA08	*	TSA28	32,74	TSB08	50,91	TSA48	76,11	TSC08	1,79	TSM08	30,60	TAD08	34,20
100	110	4"	TSA09	*	TSA29	40,63	TSB09	62,06	TSA49	93,77	TSC09	2,52	TSM09	39,60	TAD09	50,40
110	125	4 1/2"	TSA10	*	TSA30	52,80	TSB10	79,89	TSA50	119,83	TSC10	3,83	TSM10	54,00		
125	140	5"	TSA11	*	TSA31	66,86	TSB11	101,14	TSA51	150,69	TSC11	4,04	TSM11	72,90		
150	160	6"	TSA12	*	TSA32	87,09	TSB12	132,69	TSA52	196,97	TSC12	4,48	TSM12	100,80		
175	200	7"	TSA13	*	TSA33	133,54	TSB13	205,71	TSA53	308,74	TSC13	7,76	TSM13	165,60		
200	225	8"	TSA14	*	TSA34	168,86	TSB14	259,03	TSA54	392,57	TSC14	12,78	TSM14	239,40		
225	250	9"	TSA15	*	TSA35	211,71	TSB15	321,94	TSA55	482,57	TSC15	14,41	TSM15	320,40		
250	280	10"	TSA16	*	TSA36	263,49	TSB16	404,57	TSA56	606,00	TSC16	21,01	TSM16	435,60		
300	315	12"	TSA17	*	TSA37	332,06	TSB17	512,57	TSA57	770,91	TSC17	31,43	TSM17	666,00		
350	355	14"	TSA18	*	TSA38	422,23	TSB18	648,51	TSA58	980,91	TSC18	44,00	TSM18	939,60		
400	400	16"	TSA19	*	TSA39	539,83	TSB19	829,20	TSA59	1.263,77	TSC19	58,74	TSM19	1.202,40		

\* Fiyat Sorunuz



## PVC Temiz Su Ek Parçaları

Dış Çap	DEVE BOYNU			6361		6351		6342		6341		6331		
	11' - 22' Ürün Kod	Fiyat	30' - 45' Ürün Kod	Fiyat	87' Ürün Kod	Fiyat	KÖR TAPA Ürün Kod	Fiyat	Yapıştırma Muflu TE Ürün Kod	Fiyat	Geçme Muflu TE Ürün Kod	Fiyat	Yapıştırma Muflu Kapalı Dirsek Ürün Kod	Fiyat
20							TST01	1,84	TYT01	2,86			TSD01	2,35
25							TST02	2,25	TYT02	4,07			TSD02	2,86
32							TST03	2,86	TYT03	6,77			TSD03	4,29
40							TST04	3,37	TYT04	8,89			TSD04	7,87
50	TDV05	14,40	TDV25	16,20	TDV45	18,90	TST05	19,80	TYT05	9,09			TSD05	7,97
63	TDV06	27,90	TDV26	30,60	TDV46	33,30	TST06	24,30	TYT06	13,79	TMT06	39,08	TSD06	10,01
75	TDV07	43,20	TDV27	47,70	TDV47	53,10	TST07	31,50	TYT07	22,47	TMT07	60,79	TSD07	19,20
90	TDV08	68,40	TDV28	82,80	TDV48	93,60	TST08	45,90	TYT08	34,73	TMT08	86,84	TSD08	26,56
110	TDV09	88,20	TDV29	102,60	TDV49	117,00	TST09	61,20	TYT09	54,65	TMT09	123,75	TSD09	44,94
125	TDV10	132,30	TDV30	151,20	TDV50	176,40								
140	TDV11	167,40	TDV31	190,80	TDV51	239,40								
160	TDV12	237,60	TDV32	261,00	TDV52	352,80								
200	TDV13	457,20	TDV33	457,20	TDV53	644,40								
225	TDV14	642,60	TDV34	688,50	TDV54	860,40								
250	TDV15	858,60	TDV35	996,30	TDV55	1.328,40								
280	TDV16	1.083,60	TDV36	1.245,60	TDV56	1.660,50								
315	TDV17	1.582,20	TDV37	1.737,00	TDV57	2.316,60								
355	TDV18	1.989,90	TDV38	2.367,00	TDV58	3.549,60								
400	TDV19	2.807,10	TDV39	3.346,20	TDV59	5.020,20								







*A Kalite  
Ak Hizmet®*



**AKPLAS KAUÇUK LOJİSTİK SAN. TİC. LTD. ŞTİ.**

**Merkez:**

Sakarya Cad. No:27/A İpekköy/AMASYA

**Tel:** 0358 240 00 25 - 242 02 64 **Fax:** 0358 242 02 65

info@akpls.com.tr

**Şube:**

Karayolları Mah. Kadir Akdoğan Cad. No:63

Küçükköy Gaziosmanpaşa / İSTANBUL

**Tel:** 0212 649 00 25 - 649 0 444 **Fax:** 0212 649 91 30

bilgi@akpls.com.tr

**www.akpls.com.tr**